

Throttle Bodies with Integrated Stepper Motor

P/N 30.42.140-D, P/N 30.42.140-D-HT

Variants

- standard diameters D of the throttle (*see drawing*) 75 mm (2.95"), 80 mm (3.15"), 85 mm (3.35")
- possible diameters of the throttle 73 mm (2.87") to 85 mm (3.35")

Dimensions

- length/width of mounting flange 150 mm (5.91")
- hole spacing on the mounting flange 95 mm (3.74")
- height of mounting flange 76 mm (2.99")
- length including stepper motor 307 mm (12.09") (*standard version*)
332 mm (13.07") (*HT version*)
- width of stepper motor 56.4 mm (2.22")

Connections

- stepper motor 10-pole military connector

Weight

- P/N 30.42.140-75 3.8 kg (8.38 lbs)
- P/N 30.42.140-80 3.75 kg (8.27 lbs)
- P/N 30.42.140-85 3.7 kg (8.16 lbs)
- P/N 30.42.140-75-HT 3.9 kg (8.60 lbs)
- P/N 30.42.140-80-HT 3.85 kg (8.49 lbs)
- P/N 30.42.140-85-HT 3.8 kg (8.38 lbs)

Mechanical Data

- permissible vibrations 5g at 20 to 2000 Hz
- maximum rotation angle of the throttle 80°
- chemical resistance water, oil, gaseous fuels
- maximum pressure 6 bar (87 psi)
- maximum temperature of the medium flowing through 125 °C (257 °F) (*standard version*)
200 °C (392 °F) (*HT version*)

Climatic Environmental Conditions

- permissible temperature range -20 °C to +85 °C (-4 °F to +185 °F)
- maximum relative humidity 95%

Characteristics of Stepper Motor

- resolution 0.05625°
- speed (when opening 80°) 170 ms
- holding torque 1.4 Nm (1.03 lb-ft)

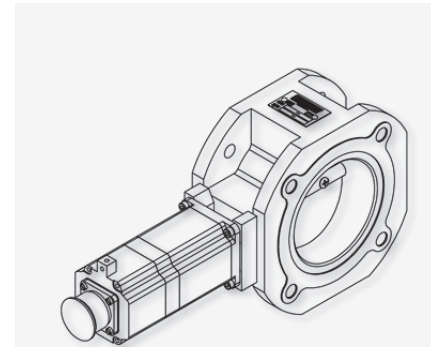

Overview Drawings

P/N 30.42.140-D

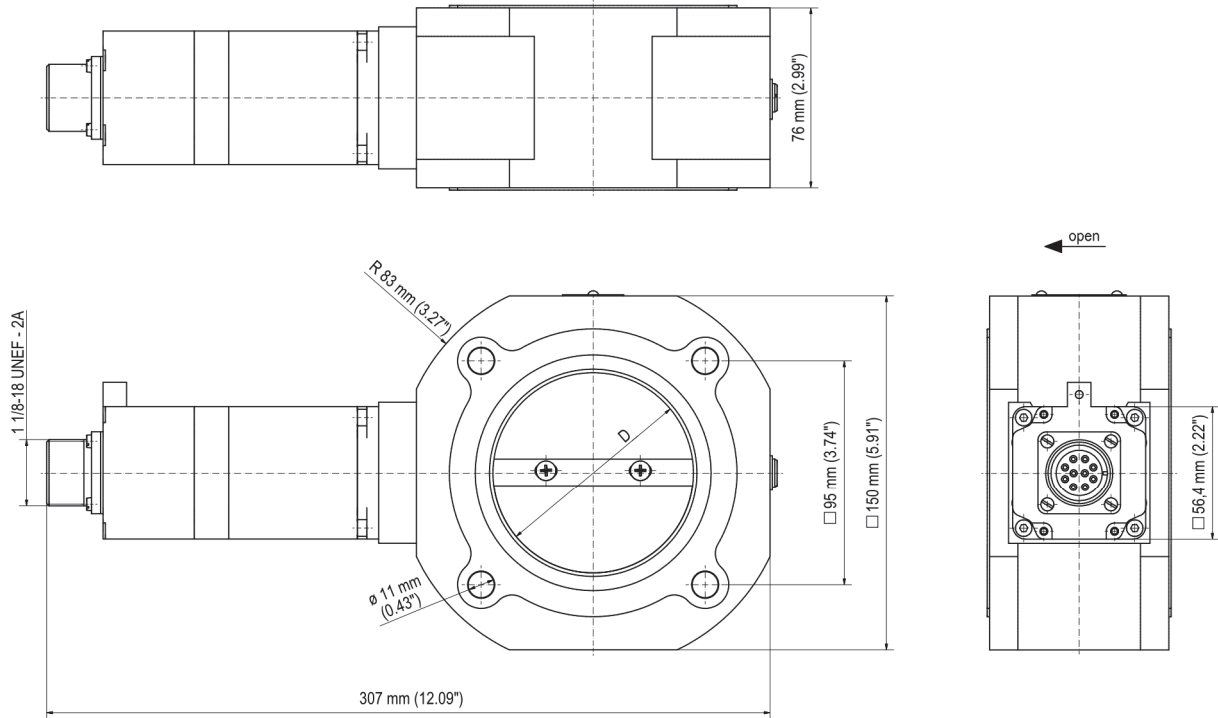

P/N 30.42.140-D-HT

