

MIC500 – IGNITION CONTROLLER

OPERATING MANUAL



MIC500
MOTORTECH IGNITION CONTROLLER

Copyright

© Copyright 2015 MOTORTECH GmbH. All rights reserved.

Distribution and reproduction of this publication or parts thereof, regardless of the specific purpose and form, are not permissible without express written approval by MOTORTECH. Information contained in this publication may be changed without prior notice.

Trademarks

All trademarks and logos displayed or used in this publication are the property of the respective entitled person.

TABLE OF CONTENTS

1 General Information	7
1.1 What Is the Purpose of this Operating Manual?	7
1.2 Who Is this Operating Manual Targeted to?	7
1.3 Which Symbols Are Used in the Operating Manual?	7
1.4 Which Abbreviations/Acronyms Are Used in the Operating Manual?	8
2 Safety Instructions	10
2.1 General Safety Instructions	10
2.2 Electrostatic Discharge Hazards	11
2.3 Special Safety Instructions for the Device	11
2.4 Proper Disposal.....	13
3 Intended Use	14
3.1 Functional Description	14
3.2 Applications.....	14
4 Product Description	15
4.1 Product Overview	15
4.2 Technical Data.....	16
4.2.1 Certifications	16
4.2.2 Mechanical Data	20
4.2.3 Warning Notices on the Device	20
4.2.4 Product Identification – Labeling on the Device	20
4.2.5 Electrical Data	21
4.2.6 Interfaces	22
4.2.7 Requirements for External Equipment	22
4.2.8 Overview Drawings	23
5 Installation Instructions	26
5.1 Unpacking	26
5.2 Determine the Installation Location of the Pickup and the Trigger Disc	26
5.3 Installation of the Ignition Controller	27
6 Wiring of the Device	28
6.1 Input and Output Wiring on the Controller	28
6.1.1 Input and Output Connector – P/N 06.00.507, P/N 06.00.508	29
6.1.2 Input and Output Connector – P/N 06.00.510.....	30
6.1.3 Input and Output Connector – P/N 06.00.511	32
6.1.4 Input and Output Connector – P/N 06.00.513.....	34
6.1.5 Input and Output Connector – P/N 06.00.514.....	36

TABLE OF CONTENTS

6.1.6 Input and Output Connector – P/N 06.00.515-6 and -8	38
6.1.7 Input and Output Connector – P/N 06.00.516	40
6.1.8 Input and Output Connector – P/N 06.00.517	42
6.1.9 Input and Output Connector – P/N 06.00.520	44
6.1.10 Input and Output Connector – P/N 06.00.525	46
6.1.11 Input and Output Connector – P/N 06.00.530	48
6.1.12 Input and Output Connector – P/N 06.00.550	50
6.1.13 Input Wiring – Power Supply	52
6.1.14 Input Wiring – 4-20 mA Input	53
6.1.15 Input Wiring – Pickup	54
6.1.16 Input Wiring – Digital Input, Go/NoGo	56
7 Functions	57
7.1 Monitoring of Pickup Signal	57
7.2 Go/NoGo	57
7.3 Remote-Controlled Ignition Release	58
7.4 Schedules A/B	59
7.5 Timing Correction	60
7.5.1 Manual Timing Correction	61
7.5.2 Analog Current Input – 4-20 mA	62
7.5.3 Speed Curve	62
7.5.4 Cylinder-to-Cylinder Alignment	62
7.6 Misfire Detection	62
7.7 Ignition Energy	63
8 Adjustments	64
8.1 Ignition Control	64
8.1.1 System Requirements Ignition Control	64
8.1.2 Installing Ignition Control	64
8.1.3 Starting Ignition Control	67
8.1.4 Menu Bar and Buttons	68
8.2 Hand-Held Programmer	69
8.2.1 RS232 Interface Adjustments	69
8.2.2 Switching on the Hand-Held Programmer	70
8.2.3 Keys of the Control Panel	71
8.3 Conventions Used in the Following	72
8.4 Main View	73
8.5 Parameterization Level	75
8.5.1 General Operation of the Parameterization Level	75

8.5.2	Brief Overview of Parameters	78
8.5.3	Set Sequence Number	80
8.5.4	Set Reset Position	84
8.5.5	Set Overspeed	84
8.5.6	Set Security Speed	85
8.5.7	Set Misfire Rate	86
8.5.8	Activate Cylinder-to-Cylinder Alignment	87
8.5.9	Select Function for Digital Input	87
8.5.10	Activate Potentiometer	88
8.5.11	Activate Functions for Schedules A and B	89
8.5.12	Set Potentiometer Limits	91
8.5.13	Set Ignition Timing Limits	93
8.5.14	Set Timing Offset for Schedule B	95
8.5.15	Set Limits for 4-20 mA Input	95
8.5.16	Set Speed Curve	97
8.5.17	Configuration Example	100
8.6	Additional Functions	102
8.6.1	Set Ignition Energy	102
8.6.2	Information View	103
8.6.3	Cylinder-to-Cylinder Alignment	103
8.6.4	Self Test	105
8.6.5	Misfire Detection	107
8.7	Programming Overview	107
9	Operation	110
9.1	Start-up	110
9.2	Shutdown	110
10	Errors	111
10.1	Possible Faults	111
10.2	Causes of Faults	111
10.2.1	Overspeed	111
10.2.2	Misfire Detection (Primary)	111
10.2.3	Pickup Input Errors	112
10.2.4	Insufficient Power Supply	112
10.2.5	Exiting Error Status	112
10.3	Troubleshooting and Eliminating Errors	113
10.3.1	Message and Error Overview	113
10.3.2	Testing Supply Voltage	114

TABLE OF CONTENTS

10.3.3 Testing Pickup Signal	114
10.3.4 Running a Self Test	116
10.3.5 Customer Service Information	117
10.3.6 Returning Equipment for Repair / Inspection	117
10.3.7 Instructions for Packaging the Equipment	118
11 Maintenance	119
11.1 Maintenance Instructions	119
11.2 Spare Parts and Accessories	119
12 Index	120

1 GENERAL INFORMATION

Read through this operating manual carefully before use and become familiar with the machine. Installation and start-up should not be carried out before reading and understanding this document. Keep this manual readily available so that you can reference it as needed.

1.1 What Is the Purpose of this Operating Manual?

This manual serves as an aid for the installation and operation of the product and supports the technical staff with all operating and maintenance tasks to be performed. Furthermore, this manual is aimed at preventing dangers to life and health of the user and third parties.

1.2 Who Is this Operating Manual Targeted to?

The operating manual provides a code of conduct for personnel tasked with the set-up, operation, maintenance, and repair of gas engines. A certain level of technical knowledge with respect to the operation of gas engines and basic knowledge of electronic ignition systems are necessary. Persons who are only authorized to operate the gas engine shall be trained by the operating company and shall be expressly instructed concerning potential hazards.

1.3 Which Symbols Are Used in the Operating Manual?

The following symbols are used in this manual and must be observed:



Example

This symbol indicates examples, which point out necessary handling steps and techniques. In addition, you receive additional information from the examples, which will increase your knowledge.



Notice

This symbol indicates important notices for the user. Follow these. In addition, this symbol is used for overviews that give you a summary of the necessary work steps.



Warning

This symbol indicates warnings for possible risks of property damage or risks to health. Read these warning notices carefully and take the mentioned precautionary measures.

1 GENERAL INFORMATION



Danger

This symbol indicates warnings for danger to life, especially due to high voltage. Read these warning notices carefully and take the mentioned precautionary measures.

1.4 Which Abbreviations/Acronyms Are Used in the Operating Manual?

In the manual or the user interface, the following abbreviations / acronyms are used:

Abb.	Term	Description	Explanation
ADV	Advance	Advanced with respect to top dead center	Indicates the direction for timing
ATDC	After Top Dead Center	After top dead center	
BTDC	Before Top Dead Center	Before top dead center	
CE	Conformité Européenne	Conformity with EU directives	Mark based on EU legislation for certain products in conjunction with product safety
°crank-shaft	Degree crankshaft		Unit for the rotation angle of the crankshaft
CSA	Canadian Standards Association		Organization that defines standards, inspects products for safety compliance, and issues pertinent certifications.
DC	Direct Current	Direct current	
EMC	Electromagnetic Compatibility		Compatibility of electrical or electronic equipment items with their surroundings
LED	Light Emitting Diode	Light emitting diode	Light emitting electronic semiconductor
POT	Potentiometer		Continuously adjustable potential divider
PWR	Power	Output / current	Operating voltage
RET	Retard	Retarded with respect to the top dead center	Indicates the direction for timing

Abb.	Term	Description	Explanation
RPM	Revolutions Per Minute	Revolutions per minute	Unit for speed
TDC	Top Dead Center		

2 SAFETY INSTRUCTIONS

2.1 General Safety Instructions

The following safety instructions must be followed in the area in which the device is operated.



High voltage! Danger to life!

While the engine is running, the area around the ignition system especially holds the risk of danger due to high voltage. The following parts should therefore not be touched or removed unless explicitly stated otherwise:

- Ignition coils and caps
- Wires of the high voltage circuit
- In- and output wiring of the ignition controller
- Pickups and their wiring



Danger to persons with pacemakers!

Electromagnetic impulses in the wiring of the ignition system may exceed the permissible limits of pacemakers. Persons with pacemakers must therefore not be present in the vicinity of the ignition system being operated. Mark the operating location of the ignition system with the corresponding standardized warning symbol.

MOTORTECH equipment is manufactured as state of the art and therefore safe and reliable to operate. Nevertheless the equipment can cause risks or damages can occur, if the following instructions are not complied with:

- The gas engine must only be operated by trained and authorized personnel.
- Operate the equipment only within the parameters specified in the technical data.
- Use the equipment correctly and for its intended use only.
- Never apply force.
- For all work, such as installation, conversion, adaptation, maintenance, and repair, all equipment must be disconnected from the power supply and secured against unintentional restarting.
- Perform only such maintenance and repair work as is described in this operating manual, and follow the instructions given while working. For maintenance of the equipment, only use spare parts supplied by MOTORTECH. Further work must only be performed by personnel authorized by MOTORTECH. Non-compliance with the instructions will void any warranties for the proper function of the equipment as well as the responsibility for the validity of the certifications.
- Safety devices must not be dismantled or disabled.
- Avoid all activities that can impair the function of the equipment.

- Operate the equipment only while it is in proper condition.
- Investigate all changes detected while operating the gas engine or ignition system.
- Ensure compliance with all laws, directives and regulations applicable to the operation of your system, including such not expressly stated herein.
- If the system is not entirely tight and sealed, gas may escape and lead to an explosion hazard. Upon completion of all assembly works, always check the system's tightness.
- Always ensure adequate ventilation of the engine compartment.
- Ensure a safe position at the gas engine.

2.2 Electrostatic Discharge Hazards

Electronic equipment is sensitive to static electricity. To protect these components from damage caused by static electricity, special precautions must be taken to minimize or prevent electrostatic discharge.

Observe these safety precautions while you work with the equipment or in its vicinity.

- Before performing maintenance or repair work, ensure that the static electricity inherent to your body is discharged.
- Do not wear clothing made from synthetic materials to prevent static electricity from building up. Your clothing should therefore be made of cotton or cotton mix materials.
- Keep plastics such as vinyl and Styrofoam materials as far away from the control system, the modules, and the work environment as possible.
- Do not remove the circuit boards from the housing of the device.

2.3 Special Safety Instructions for the Device



Danger to life! Hazardous residual voltage!

A dangerous level of residual voltage is present in the ignition system for up to three minutes after stopping the ignition. Do not touch any components of the ignition kit during this time.



Explosion hazard!

When the system is powered up, do not remove any connectors unless the system is not located in a potentially explosive atmosphere.

2 SAFETY INSTRUCTIONS



Explosion hazard!

The replacement of parts or assemblies can impair compliance with CSA Class I, Division 2 (Group C, D), T4.



Explosion hazard!

Never remove the equipment while the device is connected to a power source unless the system is not located in an explosive environment.



Risk of burning!

The surfaces of the system may heat up to high temperatures.



Operational safety!

All connector screws and screw joints must be adequately tightened. Compliance with the following tightening torques is mandatory:

- RS232 connection: 1 Nm (0.7 lb-ft)
- Connection plug 6-pole, 7-pole, 10-pole: 2.6 Nm (1.9 lb-ft)
- Connection plug 14-pole, 19-pole: 5 Nm (3.7 lb-ft)



Explosion hazard!

Never remove the cover for timing adjustment and the RS232 interface, unless the system is not located in an explosive environment.

**Risk of damage!**

Magnetic fields and heat occur when welding, which may damage or destroy the MIC500. Therefore, pay attention to the following when welding:

- Disconnect all electrical connections to the MIC500 prior to welding.
- Protect the MIC500 against direct contact with the welding unit and magnetic fields, sparks and liquid metal.

2.4 Proper Disposal

After the expiration of its service life, MOTORTECH equipment can be disposed of with other commercial waste, or it may be returned to MOTORTECH. We will ensure its environmentally friendly disposal.

3 INTENDED USE

3.1 Functional Description

The devices of the MIC500 series are microprocessor-controlled condenser discharge ignition systems, which provide the ignition energy for gas engines with up to 16 cylinders.

Please note that the manufacturer is not required to implement configurations of the ignition controller for specific engines, and that devices may be delivered without pertinent configuration.

The ignition controllers of the MIC500 series use information supplied by the pickup to precisely determine the correct timing for the respective outputs. An event type N+1 trigger disc serves as transmitter.

The timing is influenced by various inputs made either automatically or manually. This can be implemented with the installed manual potentiometer, an analog input signal (4-20 mA) or a configurable speed curve.

By checking the information received, the ignition controllers continuously monitor the system status of the pickup and the correct operation of the primary ignition circuit during operation.

Depending on the severity of an error that is detected, the devices will shut down immediately or warn the operator by a flashing LED.

To protect the engine, the ignition controllers additionally have an adjustable overspeed shut-off.

3.2 Applications













Depending on the device type, the ignition controllers of the MIC500 series are designed for specific 2- or 4-stroke gas engines. Depending on the device type, there are between 2 to max. 16 ignition outputs available.

The ignition controllers supply the energy output required for the corresponding ignition coils of the gas engines and can supply signals for peripheral devices. Any use other than the one described in the operating manual shall be considered improper use and will result in the voiding of all warranties.

4 PRODUCT DESCRIPTION

4.1 Product Overview

The following properties of the devices from the MIC500 series differ as follows:

Device type	Number of outputs	Test port / monitor voltage	Voltage for pickup
P/N 06.00.507	8	30 V DC	24 V DC
P/N 06.00.508	8	30 V DC	24 V DC
P/N 06.00.510	 16	30 V DC	24 V DC
P/N 06.00.511	 16	30 V DC	24 V DC
P/N 06.00.513	 8	300 V DC	8 V DC
P/N 06.00.514	 16	30 V DC	8 V DC
P/N 06.00.515-6	 8 (programmed on 6)	300 V DC	8 V DC
P/N 06.00.515-8	 8	300 V DC	8 V DC
P/N 06.00.516	 16 (programmed on 12)	300 V DC	8 V DC
P/N 06.00.517	 16	300 V DC	8 V DC
P/N 06.00.520	 8	300 V DC	24 V DC
P/N 06.00.525	 12	300 V DC	24 V DC
P/N 06.00.530	 16	300 V DC	24 V DC
P/N 06.00.550	 8	30 V DC	24 V DC

4 PRODUCT DESCRIPTION

4.2 Technical Data

4.2.1 Certifications

The ignition controllers of the MIC500 series with the test mark  are certified as per the following CSA standards:

CSA

- Class I, Division 2, Group C and D, T4
- CSA Std C22.2 No. 142-M1987 (Reaffirmed 2004)
- CSA Std C22.2 No. 213-M1987 (Reaffirmed 2004)

The ignition controllers of the MIC500 series are additionally certified as per the following directives/regulations:

CE

- EMC Directive 2004/108/EC
 - Limits as per DIN EN 55011:2011
 - Immunity for industrial environments as per DIN EN 61000-6-2:2006-03
 - Emission standard for industrial environments as per DIN EN 61000-6-4:2007-09
- Low Voltage Directive 2006/95/EC
 - Low voltage switchgear – General rules as per DIN EN 60947-1:2007



Certificate of Compliance

Certificate: 1641805

Master Contract: 211392

Project: 2651043

Date Issued: October 23, 2013

Issued to: **Motortech GmbH**
Hogrevestrasse 21-23
Celle, 29223
Germany
Attention: Daniel Kretzer

The products listed below are eligible to bear the CSA Mark shown



Marin Banu

Issued by: Marin Banu, P. Eng.

PRODUCTS

CLASS 2258 02 - PROCESS CONTROL EQUIPMENT - For Hazardous Locations
CLASS 2258 82 - PROCESS CONTROL EQUIPMENT - For Hazardous Locations -
Certified to US Standards

CLASS I, DIV. 2, Groups C and D, T4
• MIC 500 Ignition Controller, rated 18 to 30 Vdc. input and 300V output.

APPLICABLE REQUIREMENTS

CSA Std C22.2 No. 142-M1987 (Reaffirmed 2004) - Process Control Equipment.

CSA Std C22.2 No. 213-M1987 (Reaffirmed 2004) - Non-Incendive Electrical Equipment for Use in Class I, Division 2 Hazardous Locations

4 PRODUCT DESCRIPTION



Supplement to Certificate of Compliance

Certificate: 1641805

Master Contract: 211392

The products listed, including the latest revision described below, are eligible to be marked in accordance with the referenced Certificate.

Product Certification History

Project	Date	Description
2651043	Oct 23, 2013	Update Report 1641805 for MIC 500 Ignition Controller to include updated drawings.
2529818	Jul 28, 2012	TOR286: Update to report 1641805 for MIC Ignition Controller rated 18 to 30 VDC input and 300V output to include updated drawings.
1641805	May 18, 2005	Original Certification

CE DECLARATION OF CONFORMITY

The Company: **MOTORTECH GmbH**
Hogrevestrasse 21 - 23
29223 Celle

declares that the products: **Ignition controller MIC500**

Intended purpose: **to be used on gas-Otto-engines**

complies with the provisions of the following EC Directives:
EMC Directive 2004/108/EC
Low Voltage Directive 2006/95/EC

under consideration of following standards:
DIN EN 55011-2011
DIN EN 61000-6-2-2006:03
DIN EN 61000-6-4-2007:09
DIN EN 60947-1 : 2007

The marking of the product is: **P/N 06.00.5xx**

This declaration is submitted by:
Name: Florian Virchow Professional status: Managing Director

Celle, 13.07.2011
City, date

legally binding signature

4 PRODUCT DESCRIPTION

4.2.2 Mechanical Data

The devices of the MIC500 series have the following mechanical characteristics:

Feature	Value
Dimensions	see chapter <i>Overview Drawings</i> on page 23
Weight	2.1 kg (4.7 lbs)
Shape of device	see chapter <i>Overview Drawings</i> on page 23
Climatic environmental conditions	-40 °C to +70 °C (-40 °F to +158 °F)

4.2.3 Warning Notices on the Device

EXPLOSION HAZARD! Do not open cover for timing adjustment and RS232 interface unless area is known to be non-hazardous.

WARNING! Read and understand the installation and operating manual prior to installing or making any adjustments.

EXPLOSION HAZARD! Do not disconnect while circuit is live unless area is known to be non-hazardous. For wiring details please refer to the operating manual.

CAUTION! Do not pressure wash this ignition module. Damage to electronic components may result.

4.2.4 Product Identification – Labeling on the Device

The necessary numbers for unique product identification are on the device:

- P/N: Product number of the ignition controller
- S/N: Serial number of the ignition controller

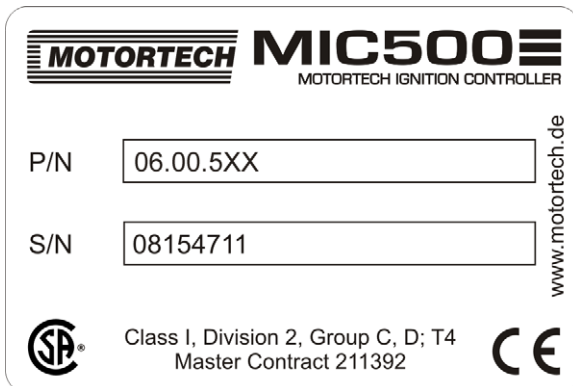

4.2.5 Electrical Data

The devices of the MIC500 series have the following electrical characteristics:

Feature	Value
Power consumption	60 W with 24 V
Power supply	18 V DC to 30 V DC
Required current	Peak current 20 A Continuous current 5 A
External fuse	6 A, slow blow
Number of ignition outputs	Depending on device type 8, 12 or 16 outputs (see <i>Product Overview</i> on page 15)
Output voltage and output energy	Max. 180 mJ with 300 V The output energy is adjustable from 15 % to 100 %.
Output connector	Depending on device type (see <i>Input and Output Wiring on the Controller</i> on page 28)

Electrical Data for Inputs and Outputs

The inputs and outputs of the MIC500 ignition controllers have the following electrical data:

Inputs and outputs	Values
4-20 mA input	Auxiliary voltage: Corresponds to supply voltage of the MIC500
Digital input	Impedance: 10 k Ω Open: 0 V to 0.8 V Closed: 2.8 V to 30 V
Go/NoGo output	Switching capacity: 100 mA Open collector output Darlington-Transistor design Voltage applied: 18 V DC to 30 V DC Peak/steady current: max. 0.45 A DC Output power: max. 2.4 W
Signal LED	An LED to display operating mode and errors
Pickup input	Impedance: 10 k Ω Power supply for inductive pickups is based on the input voltage e. g. 24 V DC with an input voltage of 24 V DC (see <i>Product Overview</i> on page 15).

4 PRODUCT DESCRIPTION

Inputs and outputs	Values
Ignition coil outputs	Output voltage: Max. 300 V Output energy: Max. 180 mJ
Test ports / monitor voltage	Depending on device type (see <i>Product Overview</i> on page 15)

4.2.6 Interfaces

RS232

- VT100-Terminal
- Baud rate: 9,600, data bits: 8, stop bit: 1, parity: none
- Plug connection: D-SUB, 9-pole
- Maximum lead length: 5 m

4.2.7 Requirements for External Equipment

External equipment shall fulfill the input and output specifications of the MIC500.

4.2.8 Overview Drawings

P/N 06.00.507, P/N 06.00.508:

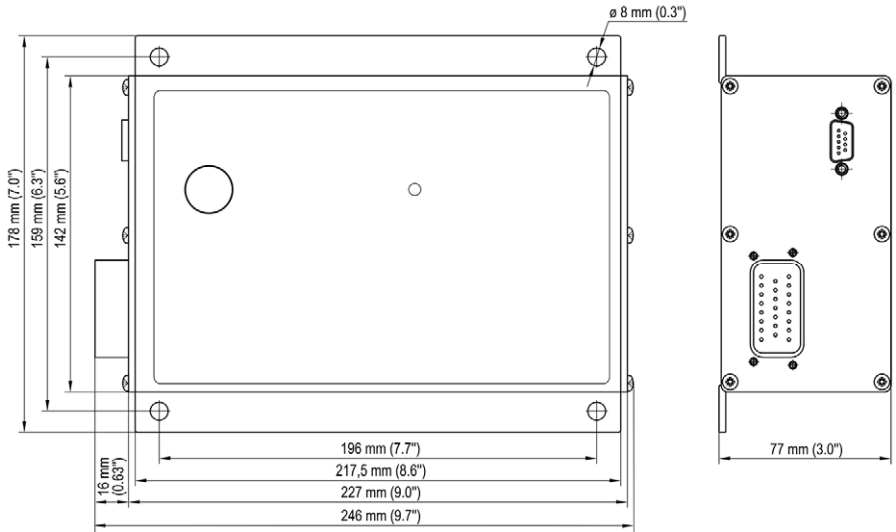

P/N 06.00.511, P/N 06.00.520, P/N 06.00.525, P/N 06.00.530, P/N 06.00.550:

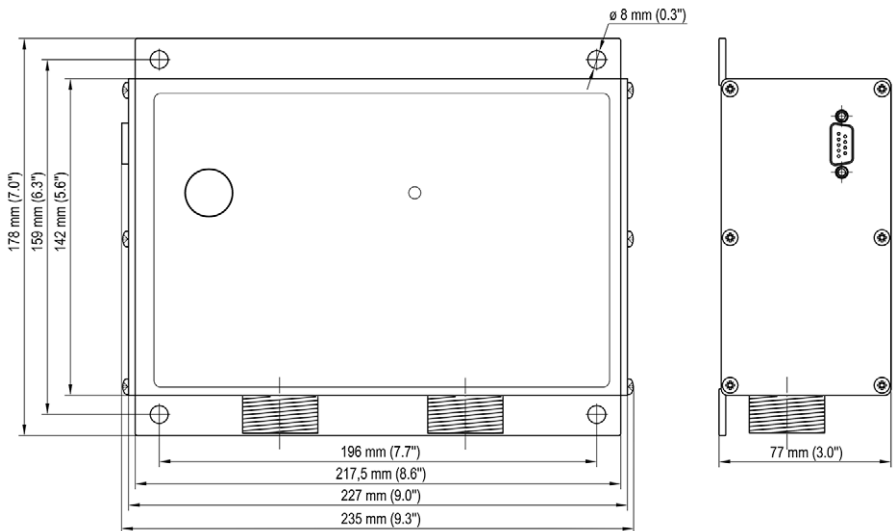

4 PRODUCT DESCRIPTION

P/N 06.00.513, P/N 06.00.514, P/N 06.00.515-6 and -8, P/N 06.00.516, P/N 06.00.517:

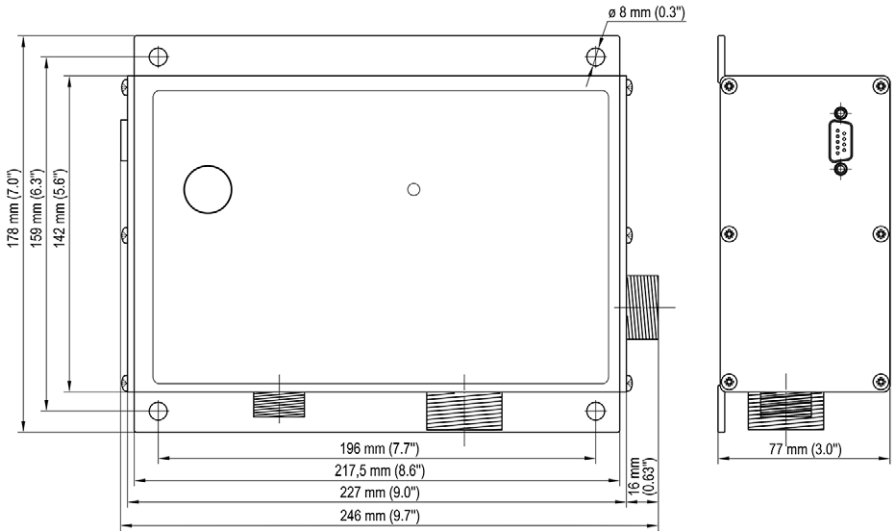

All device types:

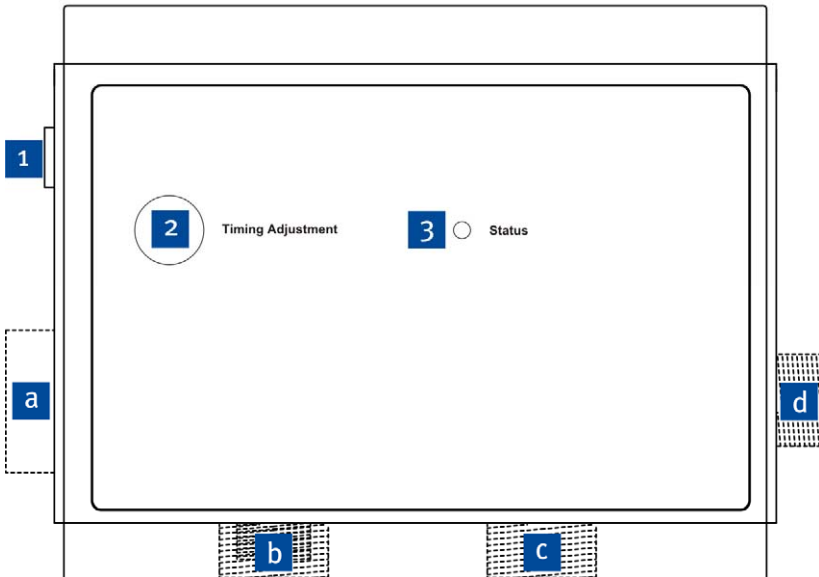

Device Components

Pos.	Labeling	Description	Function
1		RS232 connection	Connection of the ignition controller to a computer or a hand-held programmer for configuration and status monitoring (see <i>Adjustments</i> on page 64).
2	Timing adjustment	potentiometer	Potentiometer for manual timing adjustment (see <i>Manual Timing Correction</i> on page 61).
3	Status	Status LED	LED for displaying operating mode and error conditions (see <i>Message and Error Overview</i> on page 113)

Inputs and Outputs Based on Device Type

The connections for the input and output wiring vary between the device types. For detailed information, see section *Input and Output Wiring on the Controller* on page 28.

Pos.	Connection position	Function
a	Left side of device	Input and output connection, 23-pole (depending on device type)
b	Left front	Input and output connection, 6-, 7-, or 10-pole (depending on device type)
c	Right front	Input and output connection, 10-, 14-, or 19-pole (depending on device type)
d	Right side of device	Input connection, 10-pole (depending on device type)

5 INSTALLATION INSTRUCTIONS

5.1 Unpacking

Unpack the device, taking care not to damage it, and ensure that the operating manual is always stored with the ignition controller and is easily accessible. Check the contents for completeness and verify that the device type meets your application requirements.

Scope of Supply

The scope of supply of the MIC500 ignition controllers consists of the following components:

- Ignition controller MIC500
- Installation set incl. four vibration dampers
- Ground strap
- Storage device (USB flash drive or CD-ROM) with software for configuring the ignition controller
- RS232 interface cable for connecting the ignition controller with a PC/laptop or hand-held programmer
- Operating manual

5.2 Determine the Installation Location of the Pickup and the Trigger Disc

Depending on engine type and application, the position of the pickup must be specified. All angle reference information is based on:

TDC 1st cylinder / Compression cycle

The installation location for the pickup must have adequate mechanical strength and must not exceed the specified temperature ranges. The pickup is designed for its appropriate use only, multiple use of the pickup signal is not permissible. The N+1 triggering can be carried out via the crankshaft or the camshaft. Ensure good accessibility to facilitate the calibration of the pickup. Comply with the pertinent regulations for the wire routing.

The precise position of the pickup is shown in the example in chapter *Input Wiring – Pickup* on page 54.

5.3 Installation of the Ignition Controller



Risk of damage!

The device must not be installed directly on or at the engine, as vibration and heat may cause damage to electronic components.

The installation of the MIC500 ignition controller is implemented on a fixed bracket or a wall near the engine. Always use the included vibration dampers and the ground strap. The installation location of the device must be selected so that the distance to the pickup installed on the engine ensures a reliable signal transmission to the ignition controller, and so that there is adequate space for maintenance and repair work. Also ensure adequate space for the connection wiring. The mechanical specifications must be complied with. The ground strap serves to ground the ignition controller and must be used accordingly. Ensure a flawless electrical connection for this purpose.

Installation locations where strong vibrations or ambient temperatures of below $-40\text{ }^{\circ}\text{C}$ ($-40\text{ }^{\circ}\text{F}$) or above $+70\text{ }^{\circ}\text{C}$ ($+158\text{ }^{\circ}\text{F}$) are present are not permissible and result in the warranty being voided.

6 WIRING OF THE DEVICE

6.1 Input and Output Wiring on the Controller



Operational safety!

All connector screws and screw joints must be adequately tightened. Compliance with the following tightening torques is mandatory:

- RS232 connection: 1 Nm (0.7 lb-ft)
- Connection plug 6-pole, 7-pole, 10-pole: 2.6 Nm (1.9 lb-ft)
- Connection plug 14-pole, 19-pole: 5 Nm (3.7 lb-ft)



Operational safety!

Never connect more than one output to each ignition coil, as the output boards can otherwise be damaged!



Assignment of the wire colors

Take the assignment of the wire colors of the wiring harness for the input and output wiring from the wiring plan enclosed with the wiring harness.



Protection when using wiring rails

Every wiring rail on the engine block should be grounded to avoid disruptions in the device caused by secondary current in the ignition coils.

6.1.1 Input and Output Connector – P/N 06.00.507, P/N 06.00.508

Input and output connector: left side of device, 23-pole, connector

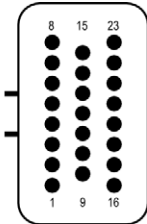

Pin	Pin assignment
1	Ignition output D
2	Ignition output C
3	Ignition output B
4	Ignition output A
5	Switch Go/NoGo
6	Not used
7	(+) 4-20 mA
8	Pickup signal
9	Ignition output E
10	Ground
11	Measuring lead (1:10)
12	(-) Supply voltage
13	(+) Supply voltage
14	Supply voltage pickup (24 V DC)
15	(-) 4-20 mA
16	Ignition output F
17	Ignition output K
18	Ignition output L
19	Digital input (Switch A/B or Switch Start/Stop)
20	Not used
21	Not used
22	4-20 mA PWR
23	Pickup ground

6 WIRING OF THE DEVICE

6.1.2 Input and Output Connector – P/N 06.00.510

Input connector: left front, 6-pole, socket

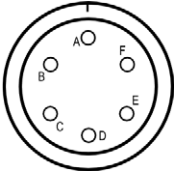

Pole	Pole assignment
A	Pickup signal
B	Supply voltage pickup (24 V DC)
C	Pickup ground
D	Switch Go/NoGo
E	(+) Supply voltage
F	(-) Supply voltage

right side of device, 10-pole, socket

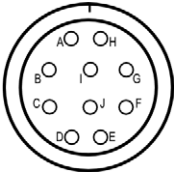

Pole	Pole assignment
A	Not used
B	Not used
C	(+) 4-20 mA
D	Digital input (Switch A/B or Switch Start/Stop)
E	(-) 4-20 mA
F	4-20 mA PWR
G	Not used

Pole	Pole assignment
H	Not used
I	Not used
J	Not used

Output connector: right front, 19-pole, socket

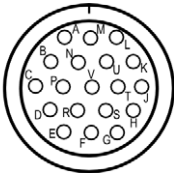

Pole	Pole assignment
A	Ignition output A
B	Ignition output B
C	Ignition output C
D	Ignition output D
E	Ignition output E
F	Ignition output F
G	Measuring lead (1:1)
H	Measuring lead (1:10)
J	Ground
K	Ignition output K
L	Ignition output L
M	Ignition output M
N	Ignition output N
P	Ignition output P
R	Ignition output R
S	Ignition output S
T	Ignition output T
U	Ignition output U
V	Ignition output V

6 WIRING OF THE DEVICE

6.1.3 Input and Output Connector – P/N 06.00.511

Input connector: left front, 10-pole, socket

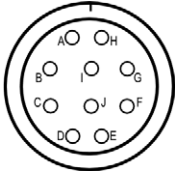

Pole	Pole assignment
A	(+) Supply voltage
B	(-) Supply voltage
C	(+) 4-20 mA
D	Digital input (Switch A/B or Switch Start/Stop)
E	(-) 4-20 mA
F	4-20 mA PWR
G	Pickup signal
H	Supply voltage pickup (24 V DC)
I	Pickup ground
J	Switch Go/NoGo

Output connector: right front, 19-pole, socket

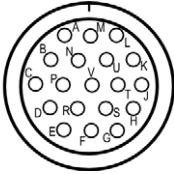

Pole	Pole assignment
A	Ignition output A
B	Ignition output B
C	Ignition output C
D	Ignition output D
E	Ignition output E
F	Ignition output F
G	Measuring lead (1:1)
H	Measuring lead (1:10)
J	Ground
K	Ignition output K
L	Ignition output L
M	Ignition output M
N	Ignition output N
P	Ignition output P
R	Ignition output R
S	Ignition output S
T	Ignition output T
U	Ignition output U
V	Ignition output V

6 WIRING OF THE DEVICE

6.1.4 Input and Output Connector – P/N 06.00.513

Input connector: left front, 6-pole, connector

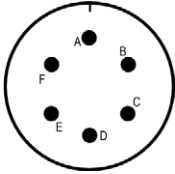

Pin	Pin assignment
A	Pickup signal
B	Supply voltage pickup (8 V DC)
C	Pickup ground
D	Switch Go/NoGo
E	(+) Supply voltage
F	(-) Supply voltage

right side of device, 10-pole, socket

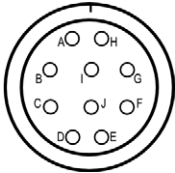

Pole	Pole assignment
A	Not used
B	Not used
C	(+) 4-20 mA
D	Not used
E	(-) 4-20 mA
F	4-20 mA PWR
G	Not used

Pole	Pole assignment
H	Not used
I	Not used
J	Not used

Output connector: right front, 10-pole, connector

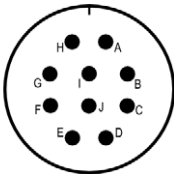

Pin	Pin assignment
A	Ignition output A
B	Ignition output B
C	Ignition output C
D	Ignition output D
E	Ignition output E
F	Ignition output F
G	Measuring lead (1:1)
H	Ignition output K
I	Ignition output L
J	Ground



No digital input at P/N 06.00.513

The device type P/N 06.00.513 is designed as a replacement for the ignition controller Caterpillar® 163-6164. Thus, the device does not have the digital input (*Switch A/B, Switch Start/Stop*) as described in this operating manual. With this device type, schedule A settings are applied solely for ignition timing configuration.

6 WIRING OF THE DEVICE

6.1.5 Input and Output Connector – P/N 06.00.514

Input connector: left front, 6-pole, connector

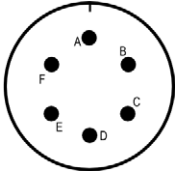

Pin	Pin assignment
A	Pickup signal
B	Supply voltage pickup (8 V DC)
C	Pickup ground
D	Switch Go/NoGo
E	(+) Supply voltage
F	(-) Supply voltage

right side of device, 10-pole, connector

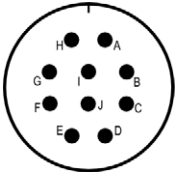

Pin	Pin assignment
A	Not used
B	Not used
C	(+) 4-20 mA
D	Digital input (Switch A/B or Switch Start/Stop)
E	(-) 4-20 mA
F	4-20 mA PWR
G	Not used

Pin	Pin assignment
H	Not used
I	Not used
J	Not used

Output connector: right front, 19-pole, connector

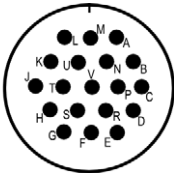

Pin	Pin assignment
A	Ignition output A
B	Ignition output B
C	Ignition output C
D	Ignition output D
E	Ignition output E
F	Ignition output F
G	Measuring lead (1:1)
H	Measuring lead (1:10)
J	Ground
K	Ignition output K
L	Ignition output L
M	Ignition output M
N	Ignition output N
P	Ignition output P
R	Ignition output R
S	Ignition output S
T	Ignition output T
U	Ignition output U
V	Ignition output V

6 WIRING OF THE DEVICE

6.1.6 Input and Output Connector – P/N 06.00.515-6 and -8

Input connector: left front, 7-pole, connector

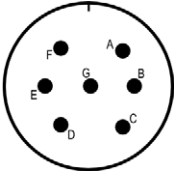

Pin	Pin assignment
A	Pickup signal
B	Supply voltage pickup (8 V DC)
C	Pickup ground
D	Digital input (Switch A/B or Switch Start/Stop)
E	(+) Supply voltage
F	(-) Supply voltage
G	Switch Go/NoGo

right side of device, 10-pole, socket

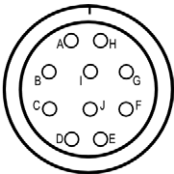

Pole	Pole assignment
A	Not used
B	Not used
C	(+) 4-20 mA
D	Ground inputs
E	(-) 4-20 mA
F	4-20 mA PWR
G	Not used

Pole	Pole assignment
H	Not used
I	Not used
J	Not used

Output connector: right front, 10-pole, connector

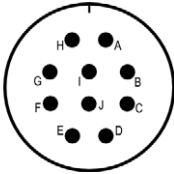

Pin	Pin assignment
A	Ignition output A
B	Ignition output B
C	Ignition output C
D	Ignition output D
E	Ignition output E
F	Ignition output F
G	Measuring lead (1:1)
H	Ignition output K
I	Ignition output L
J	Ground

6 WIRING OF THE DEVICE

6.1.7 Input and Output Connector – P/N 06.00.516

Input connector: left front, 7-pole, connector

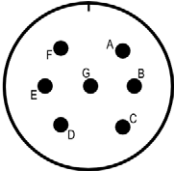

Pin	Pin assignment
A	Pickup signal
B	Supply voltage pickup (8 V DC)
C	Pickup ground
D	Digital input (Switch A/B or Switch Start/Stop)
E	(+) Supply voltage
F	(-) Supply voltage
G	Switch Go/NoGo

right side of device, 10-pole, connector

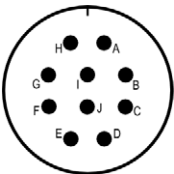

Pin	Pin assignment
A	Not used
B	Not used
C	(+) 4-20 mA
D	Ground inputs
E	(-) 4-20 mA
F	4-20 mA PWR
G	Not used

Pin	Pin assignment
H	Not used
I	Not used
J	Not used

Output connector: right front, 19-pole, connector

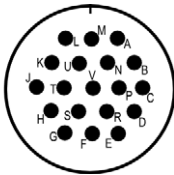

Pin	Pin assignment
A	Ignition output A
B	Ignition output B
C	Ignition output C
D	Ignition output D
E	Ignition output E
F	Ignition output F
G	Measuring lead (1:1)
H	Not used
J	Ground
K	Ignition output K
L	Ignition output L
M	Ignition output M
N	Ignition output N
P	Ignition output P
R	Ignition output R
S	Ignition output S
T	Ignition output T
U	Ignition output U
V	Ignition output V

6 WIRING OF THE DEVICE

6.1.8 Input and Output Connector – P/N 06.00.517

Input connector: left front, 7-pole, connector

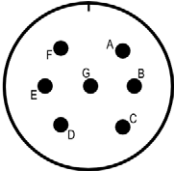

Pin	Pin assignment
A	Pickup signal
B	Supply voltage pickup (8 V DC)
C	Pickup ground
D	Digital input (Switch A/B or Switch Start/Stop)
E	(+) Supply voltage
F	(-) Supply voltage
G	Switch Go/NoGo

right side of device, 10-pole, connector

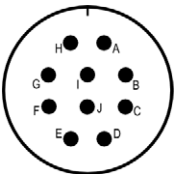

Pin	Pin assignment
A	Not used
B	Not used
C	(+) 4-20 mA
D	Ground inputs
E	(-) 4-20 mA
F	4-20 mA PWR
G	Not used

Pin	Pin assignment
H	Not used
I	Not used
J	Not used

Output connector: right front, 19-pole, connector

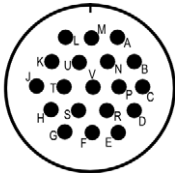

Pin	Pin assignment
A	Ignition output V
B	Ignition output A
C	Ignition output B
D	Ignition output C
E	Ignition output D
F	Ignition output E
G	Measuring lead (1:1)
H	Not used
J	Ground
K	Ignition output F
L	Ignition output K
M	Ignition output L
N	Ignition output M
P	Ignition output N
R	Ignition output P
S	Ignition output R
T	Ignition output S
U	Ignition output T
V	Ignition output U

6 WIRING OF THE DEVICE

6.1.9 Input and Output Connector – P/N 06.00.520

Input connector: left front, 10-pole, connector

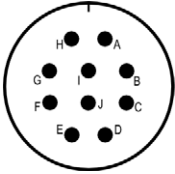

Pin	Pin assignment
A	(+) Supply voltage
B	(-) Supply voltage
C	(+) 4-20 mA
D	Digital input (Switch A/B or Switch Start/Stop)
E	(-) 4-20 mA
F	4-20 mA PWR
G	Pickup signal
H	Supply voltage pickup (24 V DC)
I	Pickup ground
J	Switch Go/NoGo

Output connector: right front, 10-pole, socket

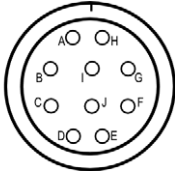

Pole	Pole assignment
A	Ignition output A
B	Ignition output B
C	Ignition output C
D	Ignition output D
E	Ignition output E
F	Ignition output F
G	Ignition output K
H	Measuring lead (1:1)
I	Ignition output L
J	Ground

6 WIRING OF THE DEVICE

6.1.10 Input and Output Connector – P/N 06.00.525

Input connector: left front, 10-pole, connector

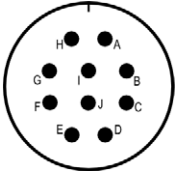

Pin	Pin assignment
A	(+) Supply voltage
B	(-) Supply voltage
C	(+) 4-20 mA
D	Digital input (Switch A/B or Switch Start/Stop)
E	(-) 4-20 mA
F	4-20 mA PWR
G	Pickup signal
H	Supply voltage pickup (24 V DC)
I	Pickup ground
J	Switch Go/NoGo

Output connector: right front, 14-pole, socket

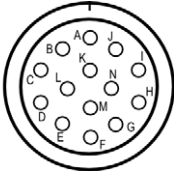

Pole	Pole assignment
A	Ignition output A
B	Ignition output B
C	Ignition output C
D	Ignition output D
E	Ignition output E
F	Ignition output F
G	Ignition output K
H	Measuring lead (1:1)
I	Ignition output L
J	Ground
K	Ignition output M
L	Ignition output N
M	Ignition output P
N	Ignition output R

6 WIRING OF THE DEVICE

6.1.11 Input and Output Connector – P/N 06.00.530

Input connector: left front, 10-pole, connector

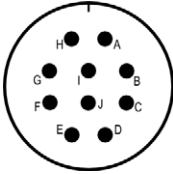

Pin	Pin assignment
A	(+) Supply voltage
B	(-) Supply voltage
C	(+) 4-20 mA
D	Digital input (Switch A/B or Switch Start/Stop)
E	(-) 4-20 mA
F	4-20 mA PWR
G	Pickup signal
H	Supply voltage pickup (24 V DC)
I	Pickup ground
J	Switch Go/NoGo

Output connector: right front, 19-pole, socket

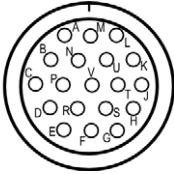

Pole	Pole assignment
A	Ignition output A
B	Ignition output B
C	Ignition output C
D	Ignition output D
E	Ignition output E
F	Ignition output F
G	Ignition output K
H	Measuring lead (1:1)
J	Ground
K	Ignition output L
L	Ignition output M
M	Ignition output N
N	Ignition output P
P	Ignition output R
R	Ignition output S
S	Ignition output T
T	Ignition output U
U	Ignition output V
V	Not used

6 WIRING OF THE DEVICE

6.1.12 Input and Output Connector – P/N 06.00.550

Input connector: right front, 14-pole, socket

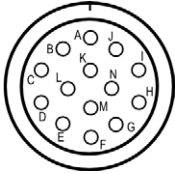

Pole	Pole assignment
A	Pickup signal
B	Pickup ground
C	Not used
D	Not used
E	Not used
F	(+) 4-20 mA
G	(-) 4-20 mA
H	Switch Go/NoGo
I	Supply voltage pickup (24 V DC)
J	Digital input (Switch A/B or Switch Start/Stop)
K	(+) Supply voltage
L	(-) Supply voltage
M	Not used
N	Not used

Output connector: left front, 10-pole, socket

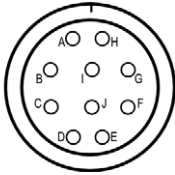

Pole	Pole assignment
A	Ignition output A
B	Ignition output B
C	Ignition output C
D	Ignition output D
E	Ignition output E
F	Ignition output F
G	Ignition output K
H	Ignition output L
I	Ground
J	Measuring lead (1:1)

6 WIRING OF THE DEVICE

6.1.13 Input Wiring – Power Supply

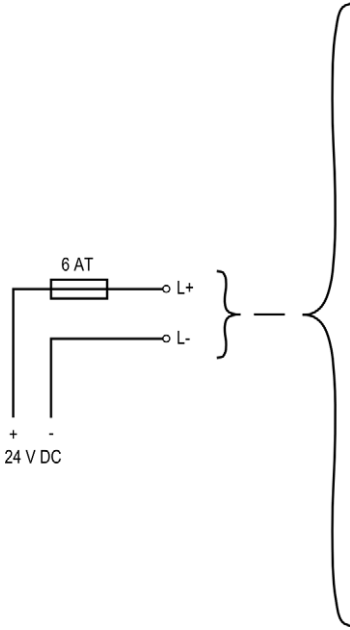

Variations			
1	Battery	Generator	Control Unit
<p>A schematic diagram showing a battery (represented by a rectangle with '+' and '-' terminals), a generator (represented by a circle with a central dot and a curved arrow), and a control unit (represented by a rectangle) connected in series.</p>			
2	Power Supply		
<p>A schematic diagram showing a power supply unit (represented by a rectangle with '+' and '-' terminals) connected to two input lines on the left and two output lines on the right, which are connected to a transformer symbol.</p>			
3	Battery	Charger	
<p>A schematic diagram showing a battery (represented by a rectangle with '+' and '-' terminals) connected to a charger (represented by a rectangle) which is connected to two output lines on the right, which are connected to a transformer symbol.</p>			

6.1.14 Input Wiring – 4-20 mA Input

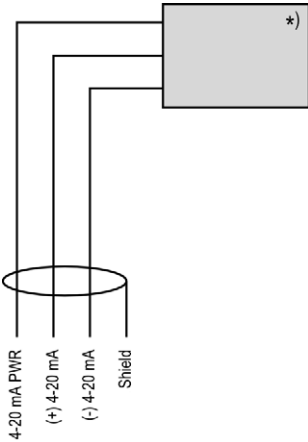

*) See subsequent drawings for details

If wiring yourself, put the shield on the connector housing.

Two-wire transmitter

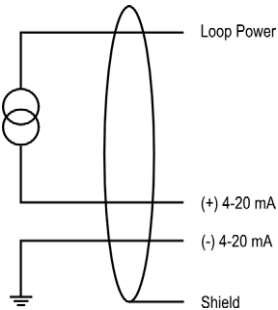

Four-wire transmitter

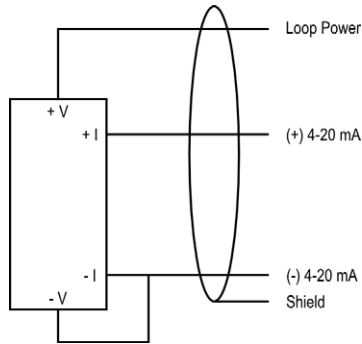

Auxiliary supply voltage for the 4-20 mA input

Via the 4-20 mA PWR terminal, the MIC500 series provides an auxiliary supply voltage for the 4-20 mA input. If using current transmitters, the 4-20 mA PWR terminal is used for Loop Power.

6 WIRING OF THE DEVICE



No 4-20 mA PWR terminal on P/N 06.00.550

The device type P/N 06.00.550 does not have a 4-20 mA PWR terminal. Thus, this device type does not provide an auxiliary supply voltage for the 4-20 mA input.

6.1.15 Input Wiring – Pickup

Example configuration (one active pickup with 8+1 trigger disc)

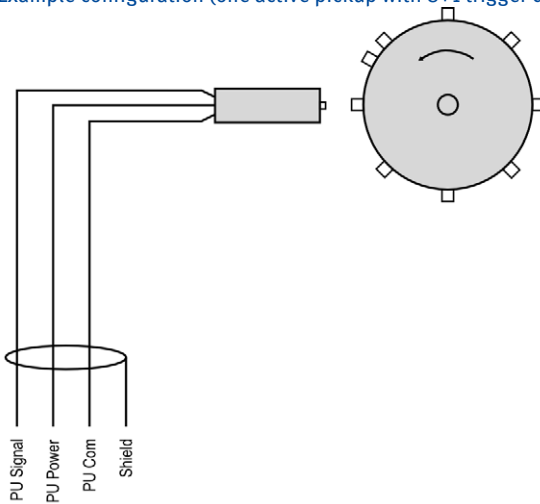

Designation	Meaning
PU Signal	Pickup signal
PU Power	Supply voltage for pickup
PU Com	Pickup ground

If wiring yourself, put the shield on the connector housing.

Connect passive (magnetic) pickup with plus to *PU Signal* and with minus to *PU Com*.

The recommended distance to the triggering is 0.75 mm to 1 mm (0.03" to 0.04") for MOTORTECH pickups. Please note that additional fine-tuning is required for every pickup position due to the different conditions of the engines.

One revolution of the pickup changes the distance as follows:

Thread	Change in distance
M12x1	1 revolution \triangleq 1 mm (0.04")
5/8"-18 UNF	1 revolution \triangleq 1.41 mm (0.05")
3/4"-16 UNF	1 revolution \triangleq 1.59 mm (0.06")

For problems with the pickup signal, see section *Pickup Input Errors* on page 112.



Auxiliary pickup supply voltage

Depending on the device type, the terminal *PU Power* provides an auxiliary supply voltage of 8 V DC or 24 V DC for the pickup. You will find an overview in the section *Product Overview* on page 15.



Triggering information

Observe the following when configuring the triggering:

- The maximum tightening torque for the counter nut is 15 Nm (11 lb-ft) for all pickups.
- Ensure that the pickup fits the respective triggering:

Pickup	Type of triggering
Magnetic	Holes, pins, screws, teeth, slots
Inductive	Pins, screws, slots, holes (as of 8 mm diameter)
Hall effect	Magnets

6 WIRING OF THE DEVICE

6.1.16 Input Wiring – Digital Input, Go/NoGo

The function of the digital input (*Switch Start/Stop* or *Switch A/B*) is specified via the parameterization of the ignition controller (see *Select Function for Digital Input* on page 87).

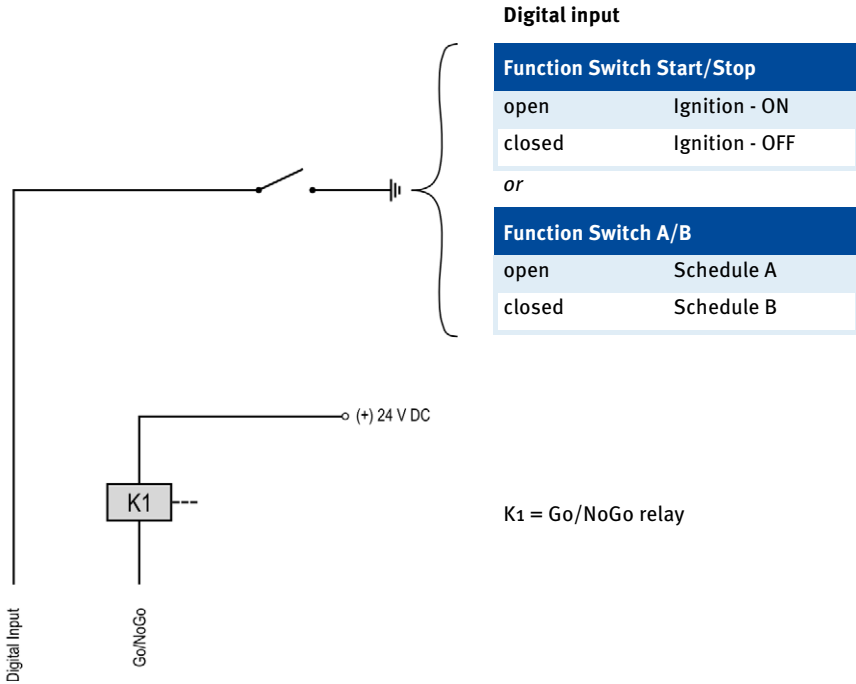

7 FUNCTIONS

The ignition controllers of the MIC500 series include freely configurable safety and auxiliary functions that, amongst others, can shut down the engine in case of fault.



Angle indications in the operating manual

All angles in this operating manual are given in °crankshaft. Exceptions are clearly identified.

7.1 Monitoring of Pickup Signal

The MIC500 monitors the pickup signal. Possible errors are indicated on the device by the LED. For further information on errors, please refer to the overview in section *Message and Error Overview* on page 113.

7.2 Go/NoGo

The Go/NoGo output is an open collector output that is closed during firing and opens when the ignition switches off. The maximum switching current is 100 mA. The output can drive an external relay that, for example, opens a gas valve.

The following errors can cause the ignition outputs to shut down:

- Overspeed
- Pickup error
- Insufficient supply voltage (Low Power)
- Misfire rate

7 FUNCTIONS

7.3 Remote-Controlled Ignition Release



No digital input at P/N 06.00.513

The device type P/N 06.00.513 is designed as a replacement for the ignition controller Caterpillar® 163-6164. Thus, the device does not have the digital input (*Switch A/B*, *Switch Start/Stop*) as described in this operating manual. With this device type, schedule A settings are applied solely for ignition timing configuration.

Via the digital input, the ignition of the MIC500 ignition controller can be switched on and off by a master control.

In order to use this function, the digital input must be set to the function *Switch Start/Stop*. In this mode, the ignition controller applies solely the settings from schedule A. If the digital input is closed, the ignition of the ignition controller is switched off.

A security speed can be specified, above which the ignition after a switch-off cannot be activated until the engine is at a standstill.

For the configuration of the digital input, see section *Select Function for Digital Input* on page 87.

For the configuration of the security speed, see section *Set Security Speed* on page 85.

7.4 Schedules A/B



Operational safety!

If you use schedules A and B, the advanced timing point should be linked to schedule B (switch closure). If a wire ruptures, schedule A is automatically selected with the retarded (and thus safer) timing point.



No digital input at P/N 06.00.513

The device type P/N 06.00.513 is designed as a replacement for the ignition controller Caterpillar® 163-6164. Thus, the device does not have the digital input (*Switch A/B*, *Switch Start/Stop*) as described in this operating manual. With this device type, schedule A settings are applied solely for ignition timing configuration.

The MIC500 ignition controllers offer two separate schedules with the following setting options:

- Timing limits
- Activating/deactivating the ignition timing adjustment via the analog input
- Activating/deactivating the speed curve
- Timing offset for schedule B

In order to use both schedules, the digital input must be set to the *Switch A/B* function (see *Select Function for Digital Input* on page 87). If the digital input is closed, the ignition controller uses the settings from schedule B. A possible application for this is e. g. operation with different gases.

To configure the schedules, read the following sections:

- *Set Ignition Timing Limits* on page 93
- *Activate Functions for Schedules A and B* on page 89
- *Set Timing Offset for Schedule B* on page 95

7 FUNCTIONS

7.5 Timing Correction



Operational safety!

The MIC500 ignition controller must first be correctly configured for the engine being used before you can start the engine.

An incorrect configuration can result in damage to the engine.

The ignition controller has several functions for ignition timing adjustment, which can be activated or deactivated. The following chart shows an overview.

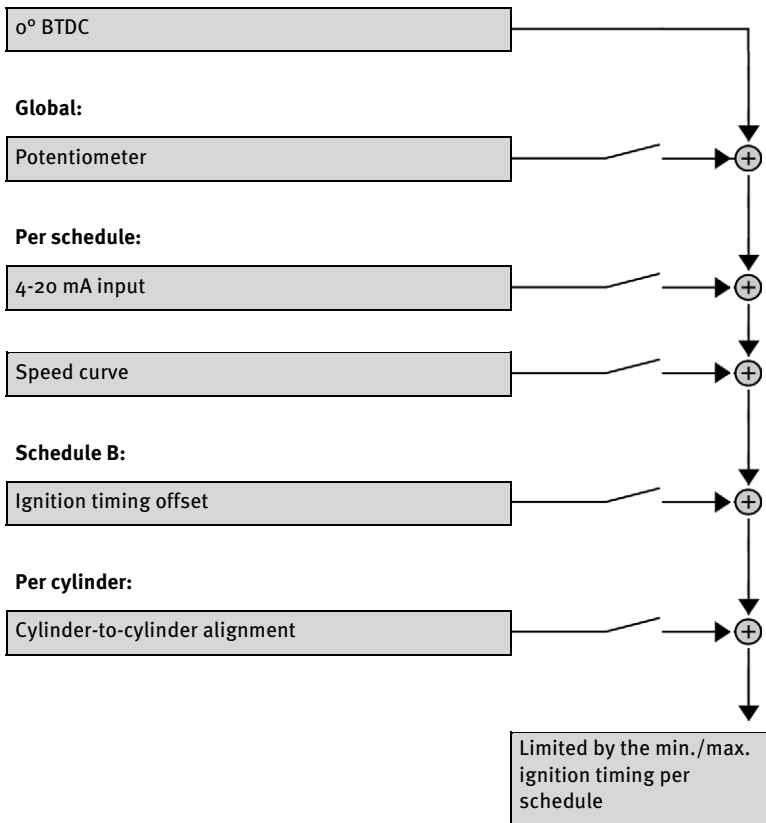

With MIC500 ignition controllers, the maximum adjustment range for ignition timing is 38° .

The various functions of the ignition timing adjustment are explained in detail in the following sections.



Influences on ignition timing

Be aware that the actual ignition timing of the engine can also be influenced by external signals (e. g. 4-20 mA input).

7.5.1 Manual Timing Correction



Explosion hazard!

Never remove the cover for timing adjustment, unless the system is not located in an explosive environment.

Reinsert the cover after every ignition timing adjustment made using the potentiometer.

The ignition controllers of the MIC500 series include a permanently installed overwind-protected potentiometer (*Timing Adjustment*) for manually adjusting the timing point. The maximum adjustment range is defined by the user through the corresponding limits.

The potentiometer can be deactivated, e.g. to prevent unauthorized changes in the timing.

The potentiometer is protected by a cover. Remove the cover only if the ignition controller is located in a non-explosive area. Reinsert the cover after every ignition timing adjustment made using the potentiometer.

To configure the potentiometer, see sections *Activate Potentiometer* on page 88 and *Set Potentiometer Limits* on page 91.

7 FUNCTIONS

7.5.2 Analog Current Input – 4-20 mA

The timing point control can be adjusted with a linear 4-20 mA signal. This signal can be supplied, for example, by a potentiometer, a pressure sensor for charging pressure, or a detonation controller.

With the analog process signal (4-20 mA current loop signal) at the 4-20 mA input, the timing point can be offset in the advanced or retarded direction within a defined range.

At the 4-20 mA PWR voltage output, the input voltage is supplied as an auxiliary voltage that can be used for supplying power to external sensors (not available for P/N 06.00.550).

To configure the analog input, see sections *Activate Functions for Schedules A and B* on page 89 and *Set Limits for 4-20 mA Input* on page 95.

7.5.3 Speed Curve

To optimize the ignition, for example, during the start phase of the engine, a speed curve can be defined for the MIC500 ignition controllers. To create this curve, up to five adjustable speed points are available.

To configure the speed curve, see sections *Activate Functions for Schedules A and B* on page 89 and *Set Speed Curve* on page 97.

7.5.4 Cylinder-to-Cylinder Alignment



Use of measuring unit

Use this setup option only if a suitable measuring unit is available for determining the optimum timing point, so that the result of a change can be assessed immediately.

To optimize combustion, the cylinder-to-cylinder alignment enables the user to change the ignition timing for individual cylinders. The ignition timing for each cylinder can be adjusted by max. 2° in both directions compared to the scheduled ignition timing.

To activate the cylinder-to-cylinder alignment, see section *Activate Cylinder-to-Cylinder Alignment* on page 87. To fine tune the individual cylinders, see section *Cylinder-to-Cylinder Alignment* on page 103.

7.6 Misfire Detection

The MIC500 ignition controllers include a misfire detection for the primary side (open circuit), which measures all misfires per cycle and compares the result to a misfire rate set by the user. If this rate is exceeded, the ignition will be automatically deactivated. For the configuration of the misfire rate, see chapter *Set Misfire Rate* on page 86.

7.7 Ignition Energy

Depending on the gas quality and the application, it is possible to vary the available ignition energy. In a range between 15 % to 100 %, any value can be selected. Fast-igniting gases such as propane require relatively small levels of energy, whereby poorly igniting gases such as landfill gas require lots of energy to ignite.

To adapt the ignition energy, see section *Set Ignition Energy* on page 102.

8 ADJUSTMENTS



Operational safety!

The MIC500 ignition controller must first be correctly configured for the engine being used before you can start the engine.

An incorrect configuration can result in damage to the engine.

Before using the MIC500 series ignition controller, all parameters relevant to the engine and the application must be configured. This parameterization can be carried out via a computer (PC/laptop) using Ignition Control software. You can also use a hand-held programmer available from MOTORTECH (P/N 06.05.008) as an option.

In addition, you receive information about the current status of your engine via the Ignition Control software or the hand-held programmer.

For help with installation and general operating instructions on Ignition Control, read chapter *Ignition Control* on page 64. For general operating instructions on the hand-held programmer, read chapter *Hand-Held Programmer* on page 69.

8.1 Ignition Control

8.1.1 System Requirements Ignition Control

The following minimum requirements must be met for the Ignition Control software:

- RS232 interface; alternatively USB 1.1 with a USB to RS232 converter
- Screen with at least QSVGA resolution (400 x 300 pixels)
- Operating system: Windows 2000 / NT / XP / 7

8.1.2 Installing Ignition Control



Explosion hazard!

Use the RS232 interface solely in a non-explosive atmosphere.

Reinsert the RS232 interface cover after each usage and tighten it with a tightening torque of 1 Nm (0.7 lb-ft).

If you want to program the ignition controller from a PC or laptop, the Ignition Control software from the supplied storage device (USB flash drive or CD-ROM) must first be installed on the computer.

Proceed as follows:

1. Select a location for saving Ignition Control on the hard disk of your computer, e.g. by creating a file folder with the name *Ignition Control*.
2. From the subdirectory *MIC software\WIN2000-NT-XP* on the supplied storage device, copy the file *IC.exe* to the location you selected on the hard disk of your computer.
3. Note the location where the Ignition Control software is saved on your computer. Put a link on the desktop if needed by *right-clicking mouse on IC.exe -> Send to -> Desktop*.



Explosion hazard!

Never remove the RS232 interface cover, unless the system is not located in an explosive environment.

4. Connect the ignition controller to your computer using the provided RS232 interface cable.
 - ▶ If your computer does not have an RS232 interface, you can also use a USB to RS232 converter. Connect the USB to RS232 converter to your computer and connect the RS232 interface cable to the RS232 connector of the converter and the ignition controller.
5. Ensure that the ignition controller is connected to the power supply and that the status LED on the ignition controller is flashing every 2 seconds for the device to be ready for operation.
6. Launch the Ignition Control software on your computer by double-clicking the *IC.exe* file.
 - ▶ The following warning is displayed:

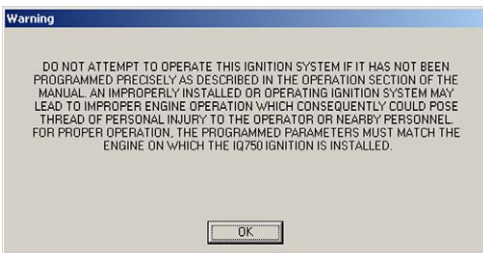

8 ADJUSTMENTS

7. Read through the information carefully and confirm with *OK*.
 - ▶ The main view is displayed.

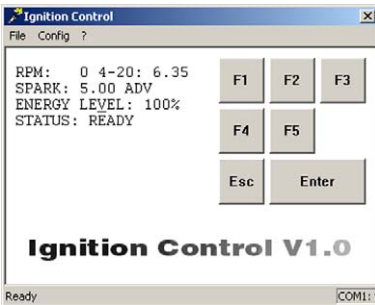

8. If you are not using *COM1* for the connection between the ignition controller and your computer, and there are no status values displayed on the left of the main view (*RPM*, *4-20*, *SPARK* etc.), adapt Ignition Control to the relevant communication interface via the menu item *Config -> RS232*:
 - ▶ The *Configuration* window is displayed.

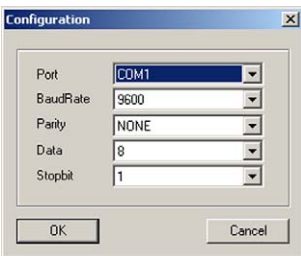

9. Select the desired interface under *Port*. All other parameters remain unchanged.
10. Confirm your selection with *OK*.
 - ▶ The window closes and the main view is displayed.

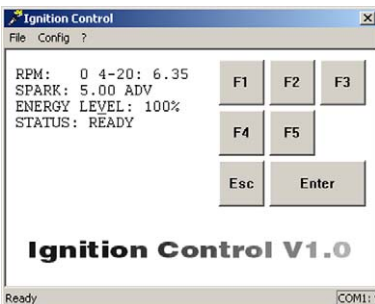

- ▶ After correctly selecting the port, you will see status values on the left side of the main view. Ignition Control is installed and ready for operation.
- ▶ If there are still no status values displayed on the left side of the main view, check the cable connection between the ignition controller and the computer (see step 4), ensure that the ignition controller is ready for operation (see step 5) as well as the selected communication interface (see step 8).

8.1.3 Starting Ignition Control

To start Ignition Control after installing it on your computer, proceed as follows:

1. Ensure that the ignition controller is connected to the power supply and that the status LED on the ignition controller is flashing every 2 seconds for the device to be ready for operation.
2. Ensure that your computer is connected with the ignition controller via the RS232 interface cable.
3. Launch the Ignition Control software on your computer by double-clicking the *IC.exe* file.
 - ▶ You see the main view.



8 ADJUSTMENTS

8.1.4 Menu Bar and Buttons





Menu Bar

The following functions are available to you via the entries in the menu bar:

Menu	Function
<i>File -> Exit</i>	Finishes Ignition Control.
<i>Config -> RS232</i>	Opens the <i>Configuration</i> window for the configuration of the RS232 interface.
<i>? -> About Ignition Control</i>	Opens information on the program.
<i>? -> Warning</i>	Opens the warning that is displayed when the program is launched.

Buttons

The following table gives an overview on the buttons and their functions. Instead of the buttons, you can also use the corresponding keys on the computer keyboard.

Button	Key	Function
	[F1] to [F5]	<i>Function keys</i> Depending on the opened view, the function keys are assigned differently. The respective assignment is shown in the view.
		
	[Esc]	<i>Leave/open parameterization level</i> With this button, you close the currently opened view and return back to main view. In the main view, you open the parameterization level with this button.
	[Enter]	<i>Confirm</i> With this button, you confirm a selection or entry.

8.2 Hand-Held Programmer

8.2.1 RS232 Interface Adjustments

If you wish to program the MIC500 ignition controller from the optionally available hand-held programmer, the RS232 interface of the hand-held programmer must be configured to correspond to the RS232 interface of the MIC500.

Proceed as follows:

1. Switch the hand-held programmer on with the [ON/OFF] key.
2. Simultaneously press [SHIFT] and [CTRL] and then also [F1].
 - ▶ The first parameter is displayed.

```

BAUD = 9600
F1-CHANGE PARAMETER
F2-NEXT   F3-PREVIOUS
F4-QUIT  F5-SAVE
```

3. Set the following parameters in succession:
 - *Baud*: 9600
 - *Data Bits*: 7
 - *Parity*: ignore
 - *Display Pe*: enabled
 - *Repeat*: fast
 - *Echo*: disabled
 - *Handshake*: disabled
 - *Self Test*: disabled
 - *Power Saver*: enabled

The respective value can be changed incrementally by pressing [F1]. You can go on to the next parameter by pressing [F2].

4. Save the settings by pressing [F5].
 - ▶ The hand-held programmer is now configured for connection with the MIC500 and ready for use.

8 ADJUSTMENTS

8.2.2 Switching on the Hand-Held Programmer



Explosion hazard!

Never remove the RS232 interface cover, unless the system is not located in an explosive environment.



Explosion hazard!

Use the RS232 interface solely in a non-explosive atmosphere.

Reinsert the RS232 interface cover after each usage and tighten it with a tightening torque of 1 Nm (0.7 lb-ft).

To switch the hand-held programmer on, proceed as follows:

1. Connect the hand-held programmer to the MIC500 ignition controller via the RS232 connector.
2. Ensure that the ignition controller is connected to the power supply and that the status LED on the ignition controller is flashing every 2 seconds for the device to be ready for operation.
3. Switch the hand-held programmer on by briefly pressing the [ON/OFF] key.
 - ▶ You see the main view.

```
RPM: 0 4-20: 6.35  
SPARK: 5.00 ADV  
ENERGY LEVEL: 100%  
STATUS: READY
```

8.2.3 Keys of the Control Panel

The following table gives an overview of the keys on the control panel and their functions.

Key	Function
[ON/OFF]	<i>On/Off key</i> Key for switching the hand-held programmer on and off
[F1] to [F5]	<i>Function keys</i> Depending on the opened view, the function keys are assigned differently. The respective assignment is shown in the corresponding view.
[+ / A] to ["/ Y], [ESC / Z]	<i>Combination letter and character keys</i> Keys for entering letters and characters. Without simultaneously pressing the shift key, the corresponding letter is entered, e.g. "A" with the [+ / A] key. If the shift key is pressed simultaneously, the corresponding character above the letter is entered, e.g. "+" with the [+ / A] key. If the shift key is pressed with the [ESC / Z] key, the ESC function is initiated (see functional description below).
[0] to [9]	<i>Number keys</i> Numbers can be entered with these keys.
[CTRL]	<i>Control key</i> Initiates the control functions of the hand-held programmer when combined with other keys.
[ESC]	<i>Leave/open parameterization level</i> With this button, you close the currently opened view and return back to main view. In the main view, you open the parameterization level with this key.
[BACKSP]	<i>Backspace key</i> Deletes the last character entered.
[SPACE]	<i>Space bar</i> Key for entering empty characters
[ENTER]	<i>Confirm</i> With this key, you confirm a selection or entry.
[SHIFT]	<i>Shift key</i> Keys with dual functions will enter the upper character or initiate the upper function if the shift key is held simultaneously.

8 ADJUSTMENTS

8.3 Conventions Used in the Following

In the subsequent sections, the views that allow you to enter settings or provide you with information will be explained. Therefore, the following conventions apply:

Key Combinations

- The keys to be pressed on the computer keyboard or the hand-held programmer are shown in square brackets, e. g. [E] indicates the E key.
- A plus symbol (+) between two keys indicates that they are to be pressed simultaneously.
- The key combinations for the computer keyboard also apply to the hand-held programmer, unless otherwise stated.
- In the Ignition Control software, the corresponding buttons (see *Menu Bar and Buttons* on page 68) can also be used.

Short Hand Notation

Setting changes to be carried out are indicated in abbreviated form, using an arrow (->) to separate the individual steps.

Example

[Shift]+[E] -> [F1] -> Enter energy level -> [Enter] -> [F5]

Meaning

1. Press the shift key and the E key simultaneously.
2. Press the F1 key or click on the F1 button in Ignition Control.
3. Enter the energy level.
4. Press the Enter key on your computer keyboard or click on the Enter button in Ignition Control.
5. Press the F5 key or click on the F5 button in Ignition Control.

Screen Views

In the following, the screen views are limited to the views in the Ignition Control software. The hand-held programmer views correspond to the Ignition Control views.

Example

Ignition Control view:

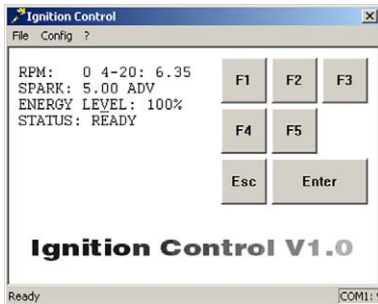

Hand-held programmer view:

```
RPM: 0 4-20: 6.35
SPARK: 5.00 ADV
ENERGY LEVEL: 100%
STATUS: READY
```

8.4 Main View

The main view is shown:

- automatically when the Ignition Control software is started or when the hand-held programmer is switched on
- when leaving other views including the parameterization level by pressing [Esc]

In the main view, you receive the following information on the current status of the MIC500 ignition controller:

- **RPM:**
current engine speed
- **4-20:**
current value of the analog current signal in mA
- **SPARK:**
currently set timing
- **ENERGY LEVEL:**
currently set energy level
- **STATUS:**
current status of the ignition controller

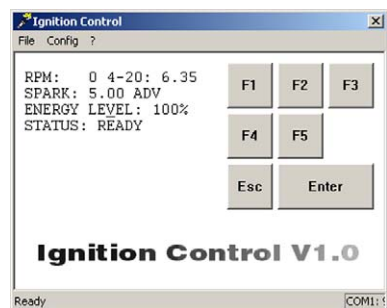

8 ADJUSTMENTS

Following statuses are possible:

- **READY**
The ignition controller is ready for operation.
- **FIRING**
The ignition controller is firing.
- **NO MPU**
No input signal detected.
- **TOO SLOW**
The speed is too slow (less than 60 crankshaft revolutions or 30 camshaft revolutions). This can be caused by an incorrect sequence number, a wrong trigger disc or a weak pickup signal.
- **WAIT FOR o**
The ignition controller is waiting for engine standstill.
- **SECURITY ON**
The Start/Stop input is closed.
- **OVERSPEED ERR**
The defined overspeed level was exceeded.
- **CAM MPU ERROR**
Errors with the pickup signal were detected.
- **OUTPUT FAILURE RATE EXCEEDS**
The defined misfire rate for the indicated output was exceeded.
- **LOW VOLTAGE**
The supply voltage has fallen below 10 V.
- **CHECKSUM ERR**
A loss in voltage occurred in programming mode, which led to a failure. The unit must be re-parameterized.

8.5 Parameterization Level

8.5.1 General Operation of the Parameterization Level

Opening Parameterization Level

The parameterization of the ignition controller is done on the parameterization level. To open this level, proceed as follows:

1. First ensure that the engine connected to the ignition controller is not running.
2. Ensure that the ignition controller is connected to the power supply and that the status LED on the ignition controller is flashing every 2 seconds for the device to be ready for operation.
3. Ensure that the ignition controller is connected to the computer or the hand-held programmer via the RS232 interface cable.
4. In order to open the parameterization level, press the [Esc] key from the main view.
 - ▶ You are requested to enter your password.



Password for the parameterization level

The password required for access to the parameterization level is obtained from your MOTORTECH contact person (see *Customer Service Information* on page 117).

8 ADJUSTMENTS

5. Enter your password and confirm it by pressing the [Enter] button.
 - ▶ After correctly entering the password, the window changes to parameter view. The MIC500 ignition controller is now in programming mode (status LED on device flashes 6 times). The parameter *SEQ. NUMBER* is displayed.

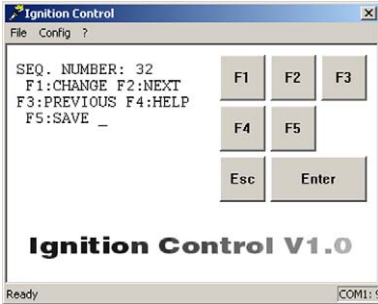

Navigating Through the Parameters

With the following keys, you can change from one parameter to the next in parameter view:

[F2]: One step further to the next parameter

[F3]: One step back to the previous parameter

Changing a Parameter

To change a parameter, proceed as follows:

1. Select the desired parameter in parameter view with [F2] or [F3].
2. To change the displayed parameter, press [F1].
 - ▶ The window for changing the relevant parameter appears.
3. Depending on the parameter, enter either the desired value or select a pre-defined value with [F1] or [F2].
4. Always confirm the values entered by pressing [Enter]. This step is omitted when pre-defined values are selected using [F1] or [F2].
 - ▶ If you do not wish to change the parameter displayed, exit the parameter configuration view by pressing [Esc]. This returns you to parameter view.
 - ▶ If you enter values beyond the permissible range for the respective parameter, these values are ignored and the existing value remains unchanged.



Save each parameter separately

The values that you change for control are not taken over by the ignition controller until you have saved the changes. Therefore, save each individual parameter change with [F5].

5. Save the parameter change with [F5]. The data is not applied by the ignition controller for control until it has been saved.
6. To change additional parameters, return to step 1.

Leaving Parameterization Level

To leave the parameterization level and return to the main view, proceed as follows:

1. From the configuration view of a parameter, press the [Esc] key to return to parameter view.
 - ▶ If you have changed the respective parameter, the change will only be saved if you press [F5] prior to exiting.
2. From the parameter view, press [Esc] to return to the main view.
 - ▶ The MIC500 ignition controller exits the programming mode and is ready for operation (LED flashes briefly every 2 seconds).

Using the Help Function

Via the help function, further information is available for every shown parameter.

- You can access help information for the displayed parameter by pressing [F4].
- You can jump between the help texts by pressing [F2] to jump a step ahead, and [F3] to jump a step back.
- You can exit the Help menu by pressing [Esc].
 - ▶ This returns you to parameter view.

8 ADJUSTMENTS

8.5.2 Brief Overview of Parameters

In the following table, you will find a brief overview of the ignition controller's configurable parameters. For more detailed information about the individual parameters, see the corresponding sections.



Display of parameters

The parameters indicated with a star (*) are dependent on the settings of other parameters and are not shown in specific instances. Detailed information on the display of these parameters can be found in the corresponding sections.

No.	Parameter	Function	Configuration
1	SEQ. NUMBER	The sequence number reflects the engine's configuration and must be set according to the connected engine.	see <i>Set Sequence Number</i> on page 80
2	RESET BTDC	Angular position of the reset signal from the upper dead center of the first cylinder	see <i>Set Reset Position</i> on page 84
3	OVERSPEED	Overspeed value, above which the ignition is switched off if exceeded.	see <i>Set Overspeed</i> on page 84
4	SECURITY SPEED	Security speed, below which the ignition can be switched on or off via the digital input if set to <i>Switch Start/Stop</i> function.	see <i>Set Security Speed</i> on page 85
5	MISFIRE RATE	Maximum permissible misfire rate, above which the engine will be switched off.	see <i>Set Misfire Rate</i> on page 86
6	CYL TO CYL	Activate or deactivate cylinder-to-cylinder alignment	see <i>Activate Cylinder-to-Cylinder Alignment</i> on page 87
7	CONTACT I/P	Use of digital input for switching the ignition on or off (function <i>Switch Start/Stop</i>) or for operating with two different schedules (function <i>Switch A/B</i>)	see <i>Select Function for Digital Input</i> on page 87
8	POT TIMING	Activate or deactivate the potentiometer	see <i>Activate Potentiometer</i> on page 88

No.	Parameter	Function	Configuration
9	SPEED CURVE A	Activate or deactivate the speed curve for schedule A	see <i>Activate Functions for Schedules A and B</i> on page 89
10	4-20 A	4-20 mA input for activating or deactivating schedule A	
11	SPEED CURVE B	Activate or deactivate the speed curve for schedule B	
12	4-20 B	4-20 mA input for activating or deactivating schedule B	
13	POT CCW	Maximum potentiometer angle BTDC with left rotating direction	see <i>Set Potentiometer Limits</i> on page 91
14	POT CW	Minimum potentiometer angle BTDC with right rotating direction	
15	MAX ADV A	Earliest permissible ignition timing for schedule A	see <i>Set Ignition Timing Limits</i> on page 93
16	MAX RET A	Latest permissible ignition timing for schedule A	
17	MAX ADV B*	Earliest permissible ignition timing for schedule B	
18	MAX RET B*	Latest permissible ignition timing for schedule B	
19	B OFFSET*	Timing offset for schedule B	see <i>Set Timing Offset for Schedule B</i> on page 95
20	4mA TIMING*	Ignition timing adjustment via the analog signal at 4 mA	see <i>Set Limits for 4-20 mA Input</i> on page 95
21	20mA TIMING*	Ignition timing adjustment via the analog signal at 20 mA	
22	DFLT 4-20*	Ignition timing adjustment in the event of signal loss at the 4-20 mA input	
23	# SPEED POINTS*	Number of speed points for the speed curve (max. 5 points)	see <i>Set Speed Curve</i> on page 97
24	BP1* to BP5*	Definition of the speed value and the ignition timing adjustment for the individual speed curve speed points BP1 to BP5	

8 ADJUSTMENTS

8.5.3 Set Sequence Number



Operational safety!

Please ensure that the set sequence number of the MIC500 ignition controller corresponds to your engine.

An incorrect configuration can result in damage to the engine.

The sequence number (*SEQ. NUMBER*) reflects the engine's configuration. The following application properties can be set with the sequence number:

- Number of outputs
- Ignition offset
- Pattern and mounting location of trigger disc
- Output firing order
- Number of combustion strokes of the engine

The sequence number that corresponds to your application can be found on the following configuration table.

If the sequence number is changed, all ignition timing adjustments of the cylinder-to-cylinder alignment (see *Cylinder-to-Cylinder Alignment* on page 103) are reset to 0°.

Proceed as follows:

Open parameterization level ->

[F2] to *SEQ. NUMBER* -> [F1] ->

Enter sequence number (see below) ->

[Enter] -> [F5]

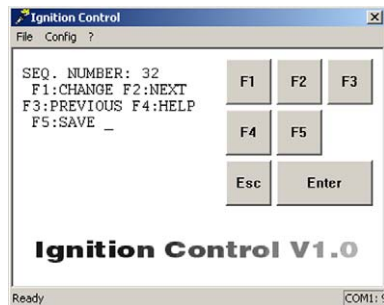

Deactivate misfire monitoring

For sequences 22, 23, 29, 34 and 36, indicated by a star (*), it is necessary to set the *MISFIRE RATE* to 0 via Ignition Control, which deactivates misfire monitoring.

Seq.	Number of outputs	Ignition offset	Trigger	Trigger disc mounting location	Ignition output	Strokes
1	2	360-360	2 + 1	Camshaft	A-B	4-stroke
2	3	240-240	3 + 1	Camshaft	A-B-C	4-stroke
3	3	120-120	3 + 1	Crankshaft	A-B-C	2-stroke
4	6	50-70	3 + 1	Crankshaft	A-B-C-D-E-F	2-stroke
5	6	30-90	3 + 1	Crankshaft	A-B-C-D-E-F	2-stroke
6	6	90-30	3 + 1	Crankshaft	A-B-C-D-E-F	2-stroke
7	2	90-90	4 + 1	Crankshaft	A-B	2-stroke
8	4	180-180	4 + 1	Camshaft	A-B-C-D	4-stroke
9	4	90-90	4 + 1	Crankshaft	A-B-C-D	2-stroke
10	8	20-70	4 + 1	Crankshaft	A-B-C-D-E-F-K-L	2-stroke
11	8	60-30	4 + 1	Crankshaft	A-B-C-D-E-F-K-L	2-stroke
12	8	45-45	4 + 1	Crankshaft	A-B-C-D-E-F-K-L	2-stroke
13	8	30-60	4 + 1	Crankshaft	A-B-C-D-E-F-K-L	2-stroke
14	5	72-72	5 + 1	Crankshaft	A-B-C-D-E	2-stroke
15	5	144-144	5 + 1	Camshaft	A-B-C-D-E	4-stroke
16	10	54-90	5 + 1	Camshaft	A-B-C-D-E-F-K-L-M-N	4-stroke
17	12	30-90	6 + 1	Camshaft	A-B-C-D-E-F-K-L-M-N-P-R	4-stroke
18	12	40-80	6 + 1	Camshaft	A-B-C-D-E-F-K-L-M-N-P-R	4-stroke
19	12	48-72	6 + 1	Camshaft	A-B-C-D-E-F-K-L-M-N-P-R	4-stroke
20	12	56-64	6 + 1	Camshaft	A-B-C-D-E-F-K-L-M-N-P-R	4-stroke
21	6	120-120	6 + 1	Camshaft	A-B-C-D-E-F	4-stroke
22*	3	60-180	6 + 1	Crankshaft	A-B-E	2-stroke
23*	4	120-60	6 + 1	Crankshaft	A-C-D-F	2-stroke
24	6	60-60	6 + 1	Crankshaft	A-B-C-D-E-F	2-stroke
25	7	102,8-102,8	7 + 1	Camshaft	A-B-C-D-E-F-K	4-stroke
26	7	51,43-51,43	7 + 1	Crankshaft	A-B-C-D-E-F-K	2-stroke
27	8	90-90	8 + 1	Camshaft	A-B-C-D-E-F-K-L	4-stroke

8 ADJUSTMENTS

Seq.	Number of outputs	Ignition offset	Trigger	Trigger disc mounting location	Ignition output	Strokes
28	8	45-45	8 + 1	Crankshaft	A-B-C-D-E-F-K-L	2-stroke
29*	8	45-45	8 + 1	Crankshaft	A-C-E-K-M-P-S-U	2-stroke
30	16	10-35	8 + 1	Crankshaft	A-B-C-D-E-F-K-L-M-N-P-R-S-T-U-V	2-stroke
31	16	21-24	8 + 1	Crankshaft	A-B-C-D-E-F-K-L-M-N-P-R-S-T-U-V	2-stroke
32	16	22,5-22,5	8 + 1	Crankshaft	A-B-C-D-E-F-K-L-M-N-P-R-S-T-U-V	2-stroke
33	16	30-60	8 + 1	Camshaft	A-B-C-D-E-F-K-L-M-N-P-R-S-T-U-V	4-stroke
34*	4	90-90	8 + 1	Crankshaft	A-E-M-S	2-stroke
35	10	36-36	10 + 1	Crankshaft	A-B-C-D-E-F-K-L-M-N	2-stroke
36*	5	72-72	10 + 1	Crankshaft	A-C-E-K-M	2-stroke
37	12	50-70	12 + 1	Camshaft	A-B-C-D-E-F-K-L-M-N-P-R	4-stroke
38	12	55-65	12 + 1	Camshaft	A-B-C-D-E-F-K-L-M-N-P-R	4-stroke
39	12	60-60	12 + 1	Camshaft	A-B-C-D-E-F-K-L-M-N-P-R	4-stroke
40	12	75-45	12 + 1	Camshaft	A-B-C-D-E-F-K-L-M-N-P-R	4-stroke
41	16	20-70	8 + 1	Camshaft	A-B-C-D-E-F-K-L-M-N-P-R-S-T-U-V	4-stroke
42	12	90-30	6 + 1	Camshaft	A-B-C-D-E-F-K-L-M-N-P-R	4-stroke
43	12	42-78	6 + 1	Camshaft	A-B-C-D-E-F-K-L-M-N-P-R	4-stroke
44	16	60-30	8 + 1	Camshaft	A-B-C-D-E-F-K-L-M-N-P-R-S-T-U-V	4-stroke
45	16	45-45	8 + 1	Camshaft	A-B-C-D-E-F-K-L-M-N-P-R-S-T-U-V	4-stroke
46	12	60-60	6 + 1	Camshaft	A-B-C-D-E-F-K-L-M-N-P-R	4-stroke

Seq.	Number of outputs	Ignition offset	Trigger	Trigger disc mounting location	Ignition output	Strokes
47	16	50-40	8 + 1	Camshaft	A-B-C-D-E-F-K-L-M-N-P-R-S-T-U-V	4-stroke
48	16	40-50	8 + 1	Camshaft	A-B-C-D-E-F-K-L-M-N-P-R-S-T-U-V	4-stroke
49	12	50-70	6 + 1	Camshaft	A-B-C-D-E-F-K-L-M-N-P-R	4-stroke
50	12	55-65	6 + 1	Camshaft	A-B-C-D-E-F-K-L-M-N-P-R	4-stroke
51	12	75-45	6 + 1	Camshaft	A-B-C-D-E-F-K-L-M-N-P-R	4-stroke
52	12	45-75	6 + 1	Camshaft	A-B-C-D-E-F-K-L-M-N-P-R	4-stroke

8 ADJUSTMENTS

8.5.4 Set Reset Position

With the *RESET BTDC* parameter, you define the angular position of the reset signal from the upper dead center of the first cylinder. All other cylinders are assessed based on this value. If there is a difference between the actual and the displayed timing, adjust this value accordingly.

Value range:

- 25.00 to 60.00 with up to two decimal places
 - ▶ Enter decimal places with a period as the delimiter, e.g. 35.55.
- The value for *RESET BTDC* must be at least 2° in advance of the earliest timing of schedule A (*MAX ADV A*) and, if activated, of schedule B (*MAX ADV B*, also see *Set Ignition Timing Limits* on page 93).

Proceed as follows:

Open parameterization level ->

[F2] to *RESET BTDC* -> [F1] ->

Enter reset position ->

[Enter] -> [F5]



8.5.5 Set Overspeed

With the *OVERSPEED* parameter, you can specify the maximum overspeed value. If this value is exceeded, the ignition is switched off and the device will indicate an error by flashing the status LED (four times).

Value range:

- 0 to 5000, whole numbers

Proceed as follows:

Open parameterization level ->

[F2] to *OVERSPEED* -> [F1] ->

Enter overspeed ->

[Enter] -> [F5]

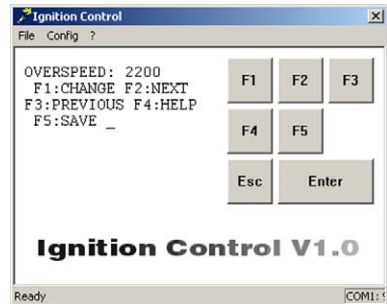

8.5.6 Set Security Speed

With the *SECURITY SPEED* parameter, you can specify the speed value for the security speed. Below this speed, the ignition can be switched on or off via the digital input if set to function *Switch Start/Stop* (see *Select Function for Digital Input* on page 87). The instant this speed is exceeded, the ignition cannot be restarted until the engine is at a standstill if shut down via the digital input.

The security speed must be greater than the maximum starter speed. It is not possible to enter values higher than the currently set overspeed (Parameter *OVERSPEED*, see *Set Overspeed* on page 84).

Value range:

- 0 to *OVERSPEED*, whole numbers

Proceed as follows:

Open parameterization level ->

[F2] to *SECURITY SPEED* -> [F1] ->

Enter security speed ->

[Enter] -> [F5]



8 ADJUSTMENTS

8.5.7 Set Misfire Rate



Deactivate misfire monitoring

For sequences 22, 23, 29, 34 and 36, it is necessary to set the *MISFIRE RATE* to 0 via Ignition Control, which deactivates misfire monitoring.

With the *MISFIRE RATE* parameter, you can specify the permissible misfires per second (primary side, open circuit) across all outputs. If the specified value is exceeded, the engine will be switched off. The exceeded misfire rate is indicated by the status LED of the device flashing six times (see *Message and Error Overview* on page 113).

Misfire monitoring can be deactivated by setting the value to 0 or 255. Depending on the engine type, setting a misfire rate of 3 to 15 is recommended.

For sequences 22, 23, 29, 34 and 36, the misfire rate must be set to 0, which deactivates misfire monitoring.

Value range:

- 0 to 255, whole numbers

Proceed as follows:

Open parameterization level ->

[F2] to MISFIRE RATE -> [F1] ->

Enter misfire rate ->

[Enter] -> [F5]



8.5.8 Activate Cylinder-to-Cylinder Alignment

With the *CYL TO CYL* parameter, you can activate the cylinder-to-cylinder alignment. This optimizes the ignition timing of the individual cylinders based on your specifications. Ignition timing optimization is carried out in a separate view outside the parameterization level. See section *Cylinder-to-Cylinder Alignment* on page 103.

Possible values:

- *ENABLE*: Cylinder-to-cylinder alignment is activated.
- *DISABLE*: Cylinder-to-cylinder alignment is deactivated.

Proceed as follows:

Open parameterization level ->

[F2] to *CYL TO CYL* -> [F1] ->

Set with [F1] to *ENABLE*

or with [F2] to *DISABLE* -> [F5]

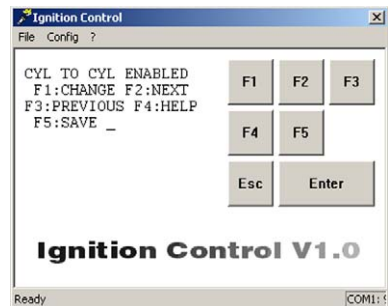

8.5.9 Select Function for Digital Input



No digital input at P/N 06.00.513

The device type P/N 06.00.513 is designed as a replacement for the ignition controller Caterpillar® 163-6164. Thus, the device does not have the digital input (*Switch A/B*, *Switch Start/Stop*) as described in this operating manual. With this device type, schedule A settings are applied solely for ignition timing configuration.

The function of the digital input is set by the *CONTACT I/P* parameter. You can choose from the following functions:

- *FOR STOP*: The digital input is set to the *Switch Start/Stop* function and is used to switch on and off the ignition. The ignition controller only applies schedule A in this configuration. For more information, read the section *Remote-Controlled Ignition Release* on page 58.
- *FOR A/B*: The digital input is set to the *Switch A/B* function and is used to switch back and forth between schedules A and B. For more information, read the section *Schedules A/B* on page 59.

8 ADJUSTMENTS

Proceed as follows:

Open parameterization level ->

[F2] to CONTACT I/P -> [F1] ->

Set with [F1] to FOR STOP

or with [F2] to FOR A/B -> [F5]

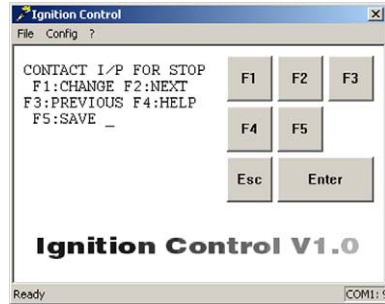

8.5.10 Activate Potentiometer



Explosion hazard!

Never remove the cover for timing adjustment, unless the system is not located in an explosive environment.

Reinsert the cover after every ignition timing adjustment made using the potentiometer.

With the *POT TIMING* parameter, you can deactivate the potentiometer at the ignition controller to avoid unauthorized changes in timing. Please observe that when the potentiometer is deactivated, the potentiometer's timing setting will also be ignored, and all other ignition timing adjustments will have the angle 0° BTDC added, regardless of the potentiometer's limits.

Possible values:

- *ENABLE*: The potentiometer of the ignition controller is activated. All other ignition timing adjustments will be added to the ignition timing adjustment of the potentiometer.
- *DISABLE*: The potentiometer of the ignition controller is deactivated. The angle 0° BTDC is added to all other ignition timing adjustments.

Proceed as follows:

Open parameterization level ->

[F2] to POT TIMING -> [F1] ->

Set with [F1] to ENABLE

or with [F2] to DISABLE -> [F5]

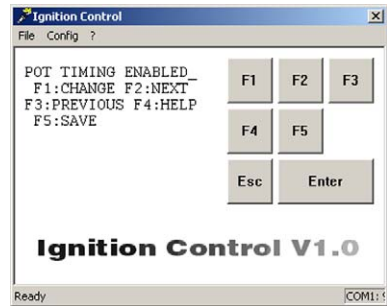

8.5.11 Activate Functions for Schedules A and B



No digital input at P/N 06.00.513

The device type P/N 06.00.513 is designed as a replacement for the ignition controller Caterpillar® 163-6164. Thus, the device does not have the digital input (*Switch A/B*, *Switch Start/Stop*) as described in this operating manual. With this device type, schedule A settings are applied solely for ignition timing configuration.

For both schedules, you can activate the *SPEED CURVE* and the ignition timing adjustment via the 4-20 mA input.

Schedule B can only be used by a master control if you select the function *Switch A/B* for the digital input (see *Select Function for Digital Input* on page 87).

The conduct of the speed curve and the 4-20 mA signal is defined in further settings, which, if activated, apply equally to schedule A and B. For more information, read section *Set Speed Curve* on page 97 and *Set Limits for 4-20 mA Input* on page 95.

Possible values:

- IN A/IN B: The respective parameter (*SPEED CURVE* or 4-20) is activated in schedule A or B.
- NOT IN A/NOT IN B: The respective parameter (*SPEED CURVE* or 4-20) is deactivated in schedule A or B.

8 ADJUSTMENTS

Proceed as follows:

Activate Speed Curve for Schedule A

Open parameterization level ->

[F2] to SPEED CURVE IN A/NOT IN A -> [F1] ->

Set with [F1] to IN A

or with [F2] to NOT IN A -> [F5]

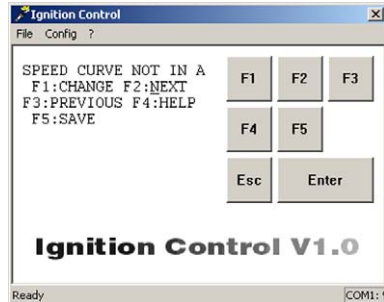

Activate 4-20 mA Input for Schedule A

Open parameterization level ->

[F2] to 4-20 IN A/NOT IN A -> [F1] ->

Set with [F1] to IN A

or with [F2] to NOT IN A -> [F5]

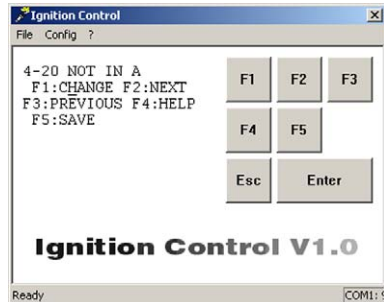

Activate Speed Curve for Schedule B

Open parameterization level ->

[F2] to SPEED CURVE IN B/NOT IN B -> [F1] ->

Set with [F1] to IN B

or with [F2] to NOT IN B -> [F5]

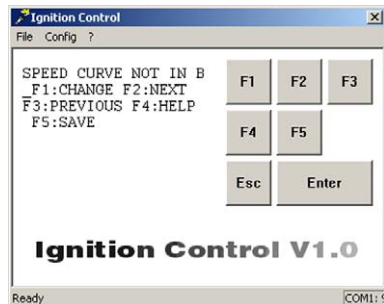

Activate 4-20 mA Input for Schedule B

Open parameterization level ->

[F2] to 4-20 IN B/NOT IN B-> [F1] ->

Set with [F1] to IN B

or with [F2] to NOT IN B -> [F5]

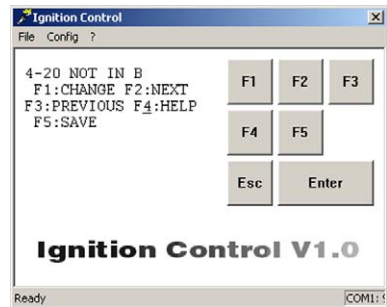

8.5.12 Set Potentiometer Limits



Explosion hazard!

Never remove the cover for timing adjustment, unless the system is not located in an explosive environment.

Reinsert the cover after every ignition timing adjustment made using the potentiometer.

You can define the range, within which the ignition timing can be adjusted with the potentiometer of the ignition controller, with the *POT CCW* and *POT CW* parameters. The rotation direction is determined by the values of both parameters. It is only possible to set values in the advance direction (ADV).

The current potentiometer setting is only applied if the potentiometer is activated (see *Activate Potentiometer* on page 88). The setting range applies equally to schedule A and B.

Value range:

- 0.00 to 58.00 with up to two decimal places
 - ▶ Enter decimal places with a period as the delimiter, e.g. 35.55.

8 ADJUSTMENTS

Proceed as follows:

Define Left Potentiometer Stop

Open parameterization level ->

[F2] to POT CCW -> [F1] ->

Enter left potentiometer stop ->

[Enter] -> [F5]

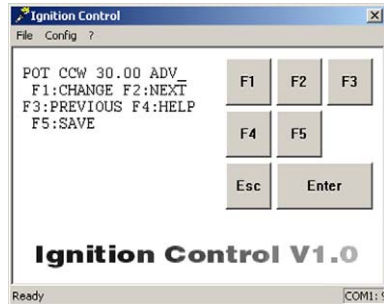

Define Right Potentiometer Stop

Open parameterization level ->

[F2] to POT CW -> [F1] ->

Enter right potentiometer stop ->

[Enter] -> [F5]

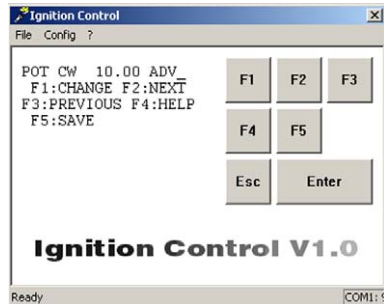

8.5.13 Set Ignition Timing Limits

To prevent engine damage caused by the addition of various parameters in the ignition timing adjustment, you can set limits which may not be exceeded for ignition timing. *MAX ADV* indicates the earliest possible firing time, *MAX RET* the latest possible firing time. Ignition timing adjustments which extend beyond these limits will only be applied up to the set limit.

The limits are specified separately for the two schedules.

The limits for schedule B can only be configured if you select the function *Switch A/B* for the digital input (see *Select Function for Digital Input* on page 87).

Value range:

- The maximum possible range of the ignition timing limits is 38°.
- The earliest possible timing (*MAX ADV*) must be at least 2° later than the reset position (parameter *Reset BTDC*, see *Set Reset Position* on page 84).
- The latest possible timing (*MAX RET*) may not be more than 40° later than the reset position (parameter *Reset BTDC*).
 - ▶ If *Reset BTDC* is set at 50°, the ignition timing limit must be set within the range of 10° BTDC to 48° BTDC. Values later than 10° are not possible.
- The value for the earliest ignition timing (*MAX ADV*) must be equal to or earlier than the value for the latest ignition timing (*MAX RET*).
- Ignition timing limits ATDC cannot be set.
- Values may have up to two decimal places.
 - ▶ Enter decimal places with a period as the delimiter, e.g. 35.55.

Proceed as follows:

Set Earliest Ignition Timing for Schedule A

Open parameterization level ->

[F2] to *MAX ADV A* -> [F1] ->

Enter earliest ignition timing ->

[Enter] -> [F5]

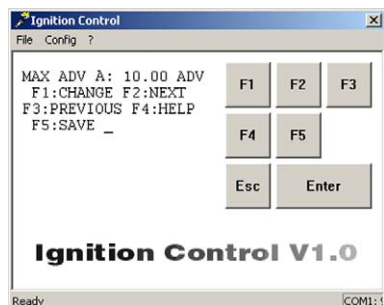

8 ADJUSTMENTS

Set Latest Ignition Timing for Schedule A

Open parameterization level ->

[F2] to MAX RET A -> [F1] ->

Enter latest ignition timing ->

[Enter] -> [F5]

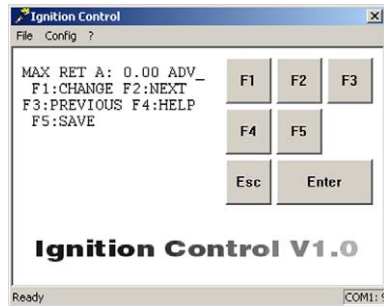

Set Earliest Ignition Timing for Schedule B

Open parameterization level ->

[F2] to MAX ADV B -> [F1] ->

Enter earliest ignition timing ->

[Enter] -> [F5]

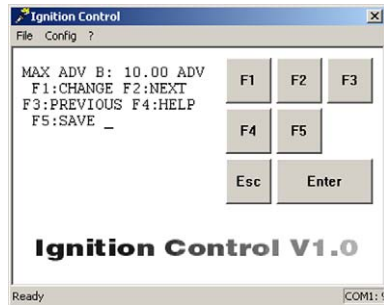

Set Latest Ignition Timing for Schedule B

Open parameterization level ->

[F2] to MAX RET B -> [F1] ->

Enter latest ignition timing ->

[Enter] -> [F5]

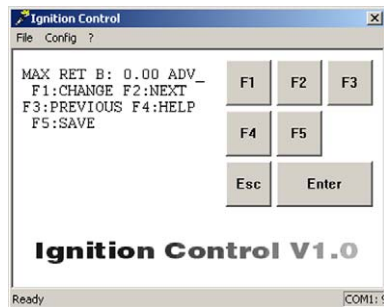

8.5.14 Set Timing Offset for Schedule B

With the *B OFFSET* parameter, you can set an ignition timing offset to offset the ignition timing for active schedule B (= digital input is closed) in addition to all other timing adjustments.

This function is only available if the digital input is set to the *Switch A/B* function, and therefore switching between both schedules is enabled (see *Select Function for Digital Input* on page 87).

Value range:

- 40.00 ADV (advance) to 40.00 RET (retard) with up to two decimal places
 - ▶ Enter decimal places with a period as the delimiter, e.g. 35.55.

Proceed as follows:

Open parameterization level ->

[F2] to B OFFSET -> [F1] ->

Enter timing offset -> [Enter] ->

Select [F1] for ADVANCE

or [F2] for RETARD -> [F5]



8.5.15 Set Limits for 4-20 mA Input

In order to set limits for the 4-20 mA input, the 4-20 mA input must be activated for at least one of the schedules A or B (see *Activate Functions for Schedules A and B* on page 89).

If the 4-20 mA input is activated, you have the possibility of adjusting the ignition timing via an external analog 4-20 mA signal.

Via the 4 mA value (parameter *4mA TIMING*) and the 20 mA value (parameter *20mA TIMING*), you can specify the span for the ignition timing adjustment. For the signals between 4 and 20 mA, the adjustment is calculated linearly towards the 20 mA value. Please refer to the example at the end of the section.

With the parameter *DFLT 4-20*, you additionally define an ignition timing adjustment in case the ignition controller detects no signal (e.g. due to a broken wire) or the incoming signal undercuts 4 mA.

Value ranges:

- 40.00 ADV (advance) to 40.00 RET (retard) with up to two decimal places
 - ▶ Enter decimal places with a period as the delimiter, e.g. 35.55.
- The values for *4mA TIMING* and *20mA TIMING* may not differ more than 40°.

8 ADJUSTMENTS

Proceed as follows:

Enter Ignition Timing Adjustment at 4 mA

Open parameterization level ->

[F2] to 4mA TIMING -> [F1] ->

Enter ignition timing adjustment ->

[Enter] -> Select [F1] for ADVANCE

or [F2] for RETARD -> [F5]

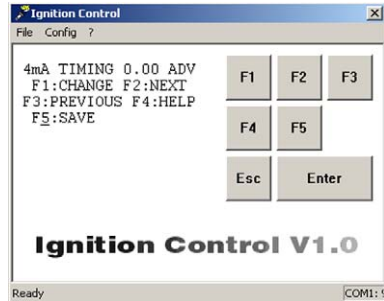

Enter Ignition Timing Adjustment at 20 mA

Open parameterization level ->

[F2] to 20mA TIMING -> [F1] ->

Enter ignition timing adjustment ->

[Enter] -> Select [F1] for ADVANCE

or [F2] for RETARD -> [F5]

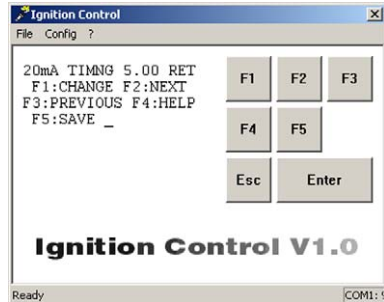

Enter Ignition Timing Adjustment in the Event of Signal Loss

Open parameterization level ->

[F2] to DFLT 4-20 -> [F1] ->

Enter ignition timing adjustment ->

[Enter] -> Select [F1] for ADVANCE

or [F2] for RETARD -> [F5]

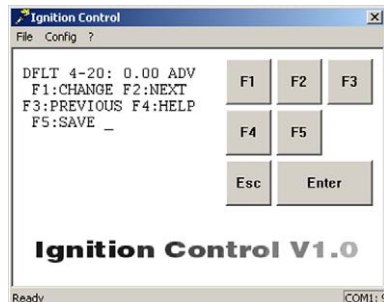



Configuration examples

Characteristic 4-20 mA – ignition timing adjustment towards retard

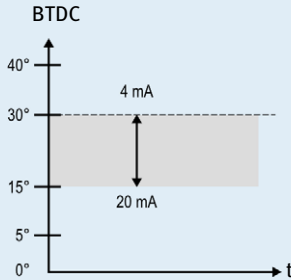

Parameterization

4mA TIMING: 0.00 ADV
20mA TIMING: 15.00 RET

15° retarded ignition if timing is at 30° BTDC

Characteristic 4-20 mA – ignition timing adjustment towards advance

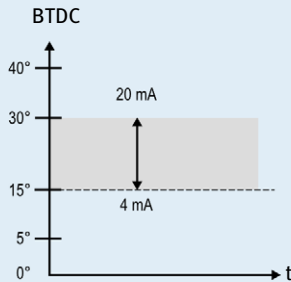

Parameterization

4mA TIMING: 0.00 ADV
20mA TIMING: 15.00 ADV

15° advanced ignition if timing is at 15° BTDC

8.5.16 Set Speed Curve

The speed curve enables the adjustment of the ignition timing based on the speed of the engine.

You can configure the speed curve as soon as you have activated it for schedule A or B (see *Activate Functions for Schedules A and B* on page 89). The setting for schedule B will only be applied if the digital input in the *Function switch A/B* allows a switch between the two schedules (see *Select Function for Digital Input* on page 87).

With the parameter # *SPEED POINTS*, you can specify the number of desired points in the speed curve. There is a maximum of five points possible. For each point (*BP1* to max. *BP5*) you can specify a speed value (*NEW SPEED*) and the corresponding timing adjustment (*NEW ANGLE*). Please also refer to the example at the end of the section.

You can only configure the same amount of speed points (*BPx*) as you set up under # *SPEED POINTS*.

8 ADJUSTMENTS

Value ranges:

- **# SPEED POINTS:** 0 to 5, whole numbers
 - ▶ If you enter the value 0 for the # *SPEED POINTS* parameter, then there is no speed curve activated and therefore no speed points can be configured.
- **NEW SPEED:** 0 to 5000, whole numbers
- **NEW ANGLE:** 40.00 ADV (advance) to 40.00 RET (retard) with up to two decimal places
 - ▶ Enter decimal places with a period as the delimiter, e.g. 35.55.

Proceed as follows:

Specify Number of Speed Points

Open parameterization level ->
[F2] to # *SPEED POINTS* -> [F1] ->
Enter number of speed points ->
[Enter] -> [F5]

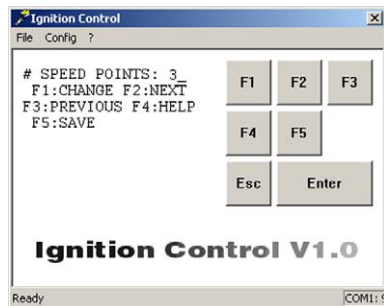

Define Speed Point

Open parameterization level ->
[F2] to to desired speed point BPx (e.g. BP1) ->
[F1] -> Enter speed value (*NEW SPEED*) ->
[Enter] -> Enter ignition timing adjustment
(*NEW ANGLE*) -> [Enter] ->
Select [F1] for ADVANCE
or [F2] for RETARD -> [F5]
(x=desired speed point)

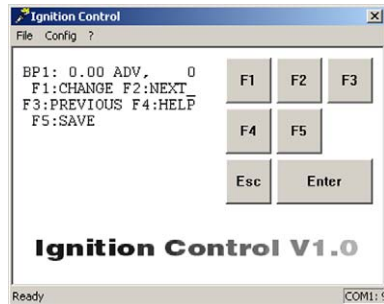



Speed Curve

Example of a typical speed curve for an engine in generator mode, for which the speed curve is intended to positively impact the start performance of the engine:

If the engine is not running, the timing is equivalent to the potentiometer setting, as in example 20° BTDC. When the engine is started, the ignition timing is reduced by 10° and above 50 revolutions it increases again, until it reaches the specified final value at 1000 revolutions.

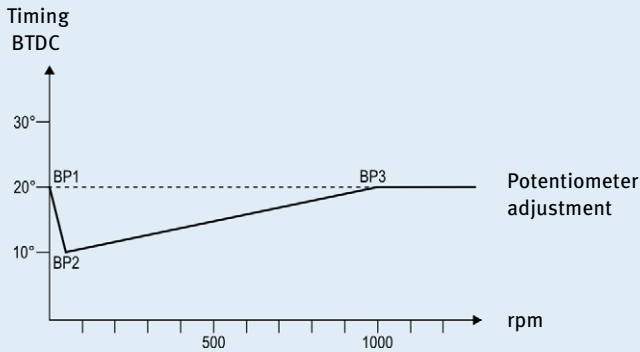

To define the speed curve, the following values are set in parameterization:

Number of speed points

SPEED POINTS: 3

Definition of the three speed points

BP1	NEW SPEED	0	No ignition timing adjustment
	NEW ANGLE	0 ADV	
BP2	NEW SPEED	50	Ignition timing adjustment by 10° retard
	NEW ANGLE	10 RET	
BP3	NEW SPEED	1000	No ignition timing adjustment
	NEW ANGLE	0 ADV	

8 ADJUSTMENTS

8.5.17 Configuration Example

The following configuration example serves to demonstrate the functionality of the MIC500 ignition controller and the effect of the individual parameter settings.

Sample Values

Parameter	Value	Parameter	Value	Parameter	Value
RESET BTDC	30°	POT CW	18° ADV	DFLT 4-20	4° RET
CONTACT I/P	FOR A/B	MAX ADV A	25° ADV	# SPEED POINTS	3
POT TIMING	ENABLED	MAX RET A	5° ADV	BP1 SPEED	0 RPM
SPEED CURVE A	IN A	MAX ADV B	23° ADV	BP1 ANGLE	0° ADV
4-20 A	IN A	MAX RET B	3° ADV	BP2 SPEED	50 RPM
SPEED CURVE B	IN B	B OFFSET	2° RET	BP2 ANGLE	15° RET
4-20 B	IN B	4mA TIMING	0° RET	BP3 SPEED	1000 RPM
POT CCW	22° ADV	20mA TIMING	6° RET	BP3 ANGLE	0° ADV

Schedule A

The setting *CONTACT I/P=FOR A/B* enables the digital input to switch back and forth between schedule A and B.

Schedule A is active if the digital input is open. The possible timing settings are limited with *MAX ADV A* and *MAX RET A* to values between 25° BTDC and 5° BTDC. With a potentiometer setting of 20 BTDC and a signal of 4 mA via the 4-20 mA input, the above configuration example has the following effect:

Timing BTDC

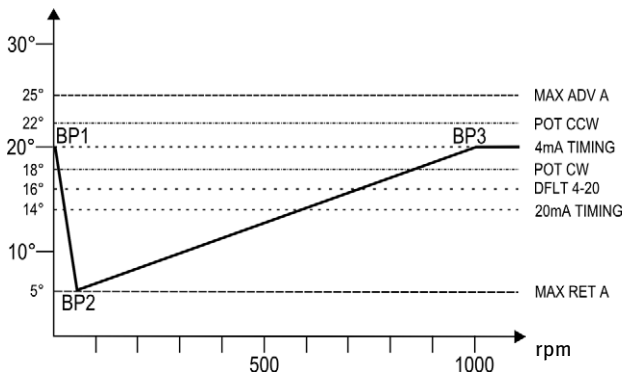

Schedule B

Schedule B is active if the digital input is closed. The possible timing settings are limited with *MAX ADV B* and *MAX RET B* to values between 23° BTDC and 3° BTDC. Because the *B OFFSET* parameter is set to 2° later, the setting ranges of the potentiometer, the 4-20 mA input, including the fail value and the speed curve are shifted based on this value. With an unchanged potentiometer setting and a signal of 4 mA via the 4-20 mA input, the above configuration example has the following effect:

Timing
BTDC

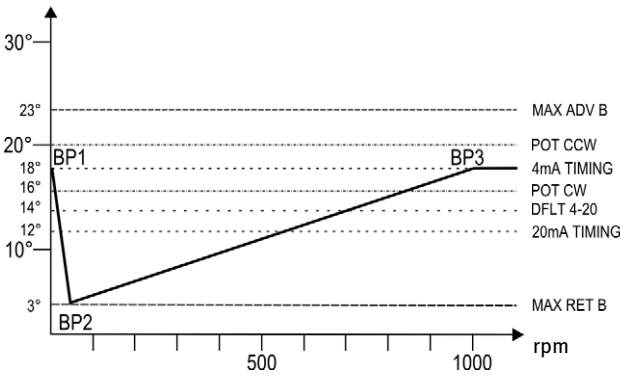

8 ADJUSTMENTS

8.6 Additional Functions

Outside the parameterization level, you can call the following additional functions, which are explained in the following sections:

- Set ignition energy
- Information view (operating hours, software revision)
- Cylinder-to-cylinder alignment
- Self test
- Misfire detection

To return to the main view after having selected an additional function, press [Esc].

8.6.1 Set Ignition Energy

In this view, the current set ignition energy level is displayed, and can be changed if needed.

Value range:

- 15 % to 100 %, whole numbers

Activate View

- Computer: [Shift]+[E]
- Hand-held programmer: [E]

Displayed Value

- **ENERGY LEVEL:**
Level currently set for ignition energy as percentage value

Change Ignition Energy

- [F1] -> Enter energy level ->
[ENTER] -> [F5]

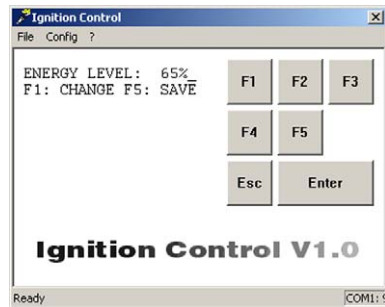

Keep in mind that by pressing the [ENTER] key, the entered energy level will be taken over immediately by the ignition control. The level is not permanently saved until [F5] is pressed.

8.6.2 Information View

In this view, you will see information on the MIC500 ignition controller.

Activate View

- Computer: [Shift]+[H]
- Hand-held programmer: [H]

Displayed Values

- **HOURS:**
Hours of operation of the ignition controller
- **CHECKSUM:**
Internal checksum of the ignition controller (relevant in some service instances)
- **SOFTWARE REV.**
Revision of the ignition controller software
- **IGNITION:**
Model name of the ignition controller



8.6.3 Cylinder-to-Cylinder Alignment



Use of measuring unit

Use this setup option only if a suitable measuring unit is available for determining the optimum timing point, so that the result of a change can be assessed immediately.

To optimize combustion, the ignition timing of the individual cylinders can be set from this view. Which of the ignition outputs can be configured, depends on the currently set sequence (see *Set Sequence Number* on page 80). If a sequence number is changed, all ignition outputs are reset to 0°.

The settings of this view are only applied by the ignition controller if the cylinder-to-cylinder alignment is activated (see *Activate Cylinder-to-Cylinder Alignment* on page 87).

8 ADJUSTMENTS

Value range:

- 2.00 ADV (advance) to 2.00 RET (retard) with up to two decimal places
 - ▶ Enter decimal places with a period as the delimiter, e.g. 35.55.

Activate View

- Computer: [Shift]+[C]
- Hand-held programmer: [C]

Displayed Values

- **OUTPUT x**
The set deviation from the scheduled ignition timing is displayed in degrees for each ignition output (x) of the ignition controller.

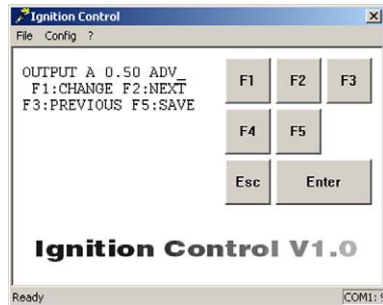

Select Ignition Output

- [F2]
Switches to next ignition output.
- [F3]
Switches to previous ignition output.

Change the Alignment Values of the Ignition Outputs

- [F2] up to the desired ignition output (e. g. OUTPUT A) -> [F1] -> Enter alignment -> Select [F1] for ADVANCE or [F2] for RETARD -> [F5]

Keep in mind that after selecting the alignment direction with [F1] or [F2], the entered value is taken over immediately by the ignition control. The value is not permanently saved until [F5] is pressed.



Note the assignment of the ignition outputs at the output connector

Note that the ignition outputs at the output connector of the individual device types are not always assigned to a pin or a pole with the same letter. The assignment of the ignition outputs to the pins or poles of the output connector can be found in chapter *Input and Output Wiring on the Controller* on page 28.



Observing different firing orders

For the firing order, a differentiation must be made between the sequence in which the outputs are switched at the ignition controller, and the sequence in which the cylinders are fired. These sequences depend on how the outputs of the ignition controller are wired to the engine's ignition coils.

For example, based on the wiring, a 6-cylinder engine can have the following firing order:

- Output firing order on MIC500: A-B-C-D-E-F
- Cylinder firing order of engine: 1-5-3-6-2-4

8.6.4 Self Test



Operational safety!

If you conduct a self test, ensure that the following conditions are met in order to avoid equipment damage or personal injury:

- The MIC500 ignition controller may not be located in a potentially explosive area.
- The gas supply must be switched off.
- There may not be any residual gas in the combustion chamber.

Please note that by activating this view, the self test starts immediately. Information on the use of the self test function for troubleshooting can be found in chapter *Running a Self Test* on page 116.

8 ADJUSTMENTS

Start Self Test

- Computer: [Shift]+[S]:
- Hand-held programmer: [S]
 - ▶ The ignition controller begins the self test immediately.

Displayed Values

- **HOURS:**
Hours of operation of the ignition controller
- **Column of figures below HOURS:**
Display of ignition outputs. All outputs that are functioning properly are indicated as 1.



Finish Self Test

To finish the self test and return to the main view, you have the following options:

- Computer: Press [Shift]+[S] or [Esc]
- Hand-held programmer: Press [S] or [ESC]



Note the assignment of the ignition outputs at the output connector

Note that the ignition outputs at the output connector of the individual device types are not always assigned to a pin or a pole with the same letter. The assignment of the ignition outputs to the pins or poles of the output connector can be found in chapter *Input and Output Wiring on the Controller* on page 28.



Misfire Detection

Which of the displayed outputs can actually be fired, depends on the set sequence number (see *Set Sequence Number* on page 80). The ignition sequence depends on how the outputs of the ignition controller are wired to the ignition coils.

8.6.5 Misfire Detection

In this view, the current status of the misfire detection is displayed.

Activate View

- Computer: [Shift]+[M]
- Hand-held programmer: [M]

Displayed Values

- **OUTPUTS**
Display of ignition outputs and their status. All outputs that are functioning properly are indicated as 1.
- **MISS/SEC**
Display of the total number of misfires of all ignition outputs per second

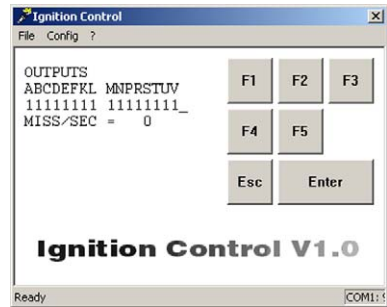

Note the assignment of the ignition outputs at the output connector

Note that the ignition outputs at the output connector of the individual device types are not always assigned to a pin or a pole with the same letter. The assignment of the ignition outputs to the pins or poles of the output connector can be found in chapter *Input and Output Wiring on the Controller* on page 28.



Misfire Detection

Which of the displayed outputs can actually be fired, depends on the set sequence number (see *Set Sequence Number* on page 80). The ignition sequence depends on how the outputs of the ignition controller are wired to the ignition coils.

8.7 Programming Overview

In the following programming overview, you can enter the configuration you selected to complete your documentation. The numbers ahead of the parameters correspond to the numbers in the overview in section *Brief Overview of Parameters* on page 78.

8 ADJUSTMENTS

Programming Overview

Customer:			
P/N Ignition controller:		P/N Ignition system:	
Engine type:			
Engine serial number:		Software revision:	
Number of cylinders:		Ignition timing:*	

*Caution! The ignition timing must be adjusted to the respective application prior to start-up.

1	SEQ. NUMBER		
2	RESET BTDC		
3	OVERSPEED		
4	SECURITY SPEED		
5	MISFIRE RATE		
6	CYL TO CYL	<input type="radio"/> ENABLED	<input type="radio"/> DISABLED
7	CONTACT I/P	<input type="radio"/> FOR STOP	<input type="radio"/> FOR A/B
8	POT TIMING	<input type="radio"/> ENABLED	<input type="radio"/> DISABLED
9	SPEED CURVE A	<input type="radio"/> IN A	<input type="radio"/> NOT IN A
10	4-20 A	<input type="radio"/> IN A	<input type="radio"/> NOT IN A
11	SPEED CURVE B	<input type="radio"/> IN B	<input type="radio"/> NOT IN B
12	4-20 B	<input type="radio"/> IN B	<input type="radio"/> NOT IN B
13	POT CCW	<input type="radio"/> ADV	
14	POT CW	<input type="radio"/> ADV	
15	MAX ADV A	<input type="radio"/> ADV	
16	MAX RET A	<input type="radio"/> ADV	
17	MAX ADV B	<input type="radio"/> ADV	only if 7 set to FOR A/B
18	MAX RET B	<input type="radio"/> ADV	only if 7 set to FOR A/B

19	B OFFSET	° ADV/RET	only if 7 set to FOR A/B
20	4mA TIMING	° ADV/RET	only if 10 or 12 enabled
21	20mA TIMING	° ADV/RET	only if 10 or 12 enabled
22	DFLT 4-20	° ADV/RET	only if 10 or 12 enabled
23	# SPEED POINTS		only if 9 or 11 enabled

24		BP1	BP2	BP3	BP4	BP5
	SPEED					
	ANGLE ADV/RET					

Additional Functions

25	[SHIFT]*+[E]	Energy (15%–100%):	
	[SHIFT]*+[H]	Operating hours:	

26	[SHIFT]*+[C]	Cylinder-to-cylinder alignment:	only if 6 enabled														
	Ignition output	A	B	C	D	E	F	K	L	M	N	P	R	S	T	U	V
	Firing order																
	Deviation																
	ADV																
	RET																

27	[SHIFT]*+[S]	Activate self test
	[SHIFT]*+[M]	Display misfires per sec.
	[SHIFT]*+[R]	Reset errors

* if using the Ignition Control software, also press [SHIFT]

Place, date

Signature

9 OPERATION

9.1 Start-up

Before you start up the MIC500 ignition controller, take note of the following:

- Does the ignition sequence fit the engine? If you are unsure, contact MOTORTECH or the corresponding engine manufacturer.
- Ensure that the firing order of the engine and/or the wiring of the output cable harness are carried out correctly.
- Is the pickup wired correctly (see chapter *Input Wiring – Pickup* on page 54)?
- Is the distance of the pickup to the trigger disc, retractor pins, etc. set correctly (see chapter *Input Wiring – Pickup* on page 54)?
- Ensure that the configuration is correctly stored in the device.
- Digital input configured as *Switch Start/Stop*:
Check whether the start/stop input is set to *Firing active*, or whether it works according to the control requirements of the master control.
- Digital input configured as *Switch A/B*:
Check whether the input contact for schedule A/B is functions and ensure that the correct schedule (A or B) is selected for start-up.
- Ensure that no gas is present in the inlet and exhaust systems before you start the engine.
- Ensure that the gas valve is closed.
- Perform the normal engine start-up process while the gas valve is closed (start only).
- Connect a stroboscope to the first firing cylinder (cylinder #1) and check whether the timing point set on the ignition controller coincides with the actual timing point on the crankshaft. If the ignition timing does not coincide exactly, change it until an optimal setting is reached. If the ignition does not fire, read the instructions in section *Troubleshooting and Eliminating Errors* on page 113.
- Check all other cylinders for correct ignition. If they are not correct, stop the engine, and recheck wiring and ignition sequence for correctness.
- Stop the starting process. If no problems occur, start the engine in accordance with the specifications of the engine manufacturer.

9.2 Shutdown

The ignition controller is shut down by disconnecting it from the power supply.

10 ERRORS

10.1 Possible Faults

The MIC500 ignition controllers include several safety functions that can shut down the engine in case of fault:

- Overspeed protection
- External shutdown contact (if digital input is set to function *Switch Start/Stop*)
- Misfire detection (primary)
- Shutdown in the case of a faulty pickup or a faulty pickup signal
- Faulty voltage supply

10.2 Causes of Faults

The ignition system consists of the following elements, which must be considered for troubleshooting:

- Ignition controller
- Cable harness
- Ignition coils
- Ignition lead
- Ground leads
- Spark plugs
- Shut-down equipment

In most cases, the cause for ignition system breakdown lies outside the ignition controller. The cause can be in one of the aforementioned components or it may be an error within the connections.

10.2.1 Overspeed

The engine speed has exceeded the set overspeed value.

Potential causes:

- Speed controller does not function properly
- Fuel supply to engine is not optimal.
- Faulty pickup signal

10.2.2 Misfire Detection (Primary)

Misfiring due to an open circuit on the primary side was detected.

Potential causes:

- Defect in the output wiring
- Ignition coil defective

10 ERRORS

10.2.3 Pickup Input Errors

The input signal from the pickup is faulty.

Potential causes:

- Number of teeth on the flywheel does not match the set number.
- Interference in the wiring of the pickup
- Wiring of the pickup incorrect
- Distance of the pickup incorrect
- Dirt on the pickup

10.2.4 Insufficient Power Supply

An error has occurred in the power supply to the MIC500.

Potential causes:

- The size of the power supply is too small
- Low battery
- Power supply wiring defective
- The power supply wiring is routed incorrectly

10.2.5 Exiting Error Status

Prior to exiting error status, ensure that the connected engine is not running.

The following options are available for exiting error status:

- Computer: briefly press [Shift]+[R]
- Hand-held programmer: briefly press [R]
- Disconnecting the supply voltage at the MIC500

10.3 Troubleshooting and Eliminating Errors

10.3.1 Message and Error Overview

The following errors and notifications are indicated on the device by an LED. The flash signals have the following meaning:

LED Signals in Fault-free Operation

Flash signal	Description
Slow flashing (every 2 seconds)	Ready for operation
Fast flashing (every 0.6 seconds)	Normal operation with ignition
Flashes six times	Ignition controller is in programming mode
Single flash, then LED is off	After an error, the ignition controller was restarted by disconnecting the supply voltage. The ignition controller is ready for operation.

LED Signals in Error Status

Flash signal	Description	Potential causes
Two flashes	Faulty pickup signal	<ul style="list-style-type: none"> – Defective pickup – Weak pickup signal – Firing sequence does not correspond to the trigger disc – Incorrectly installed trigger disc
Three flashes	Engine speed too slow	<ul style="list-style-type: none"> – Speed too low (less than 60 crankshaft or 30 camshaft revolutions) – Firing sequence does not correspond to the trigger disc – Incorrectly installed trigger disc
	Ignition release is blocked	<ul style="list-style-type: none"> – In <i>Switch Start/Stop</i> mode: Start/Stop input not opened during engine start
Four flashes	Shutdown due to overspeed	<ul style="list-style-type: none"> – Maximum speed exceeded
Five flashes	Input voltage too low	<ul style="list-style-type: none"> – Defective power supply or defective battery – Underdesigned wiring

10 ERRORS

Flash signal	Description	Potential causes
Flashes six times	Misfire rate exceeded on the supply side	<ul style="list-style-type: none">– Defect in the output wiring– Ignition coil defective
	Ignition controller waiting for standstill	<ul style="list-style-type: none">– In <i>Switch Start/Stop</i> mode: Start/Stop input closed due to speed exceeding security speed, ignition release blocked until engine standstill

10.3.2 Testing Supply Voltage



Risk of damage!

Supply voltage below the defined values will impair the ignition kit function and can cause the engine to stop running. If the maximum value is exceeded, the ignition controller may be damaged.

The supply voltage must comply with the following values:

- Minimum 18 V DC
- Maximum 30 V DC

If you suspect a supply voltage interruption, test for this using an oscilloscope. Provided that you use the digital input for the *Switch Start/Stop* function, check the Start/Stop control for leads which may be open, short-circuited or unintentionally grounded.

10.3.3 Testing Pickup Signal

If the pickup transmits a faulty signal during operation, the ignition controller will automatically stop the ignition. This type of error can be caused by a pickup failure, an open or short circuited or grounded lead to the pickup, or by a change in the pickup's properties.

Proceed as follows:

- Start the engine with the gas valve closed.
- Using an oscilloscope, test the pickup's signal.
- Ensure that the square wave signal is no less than 2.5 V.

Ideal pickup signal sequence

- with a magnetic sensor:

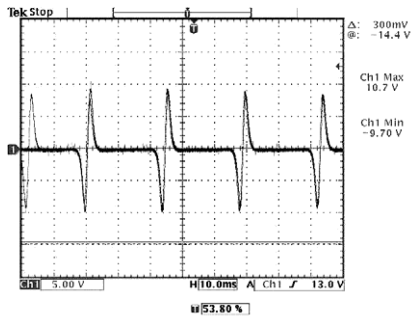

- with an inductive sensor:

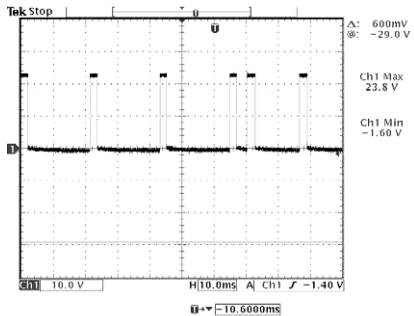

- with a Hall effect sensor:

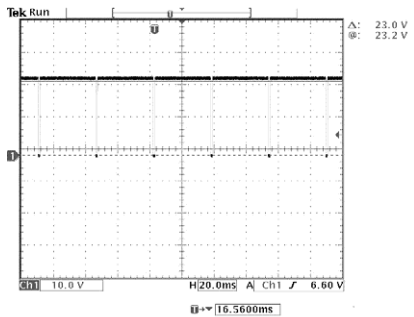

10 ERRORS



LEDs of an active pickup

If you are using an active pickup (Hall effect or inductive), it has two LEDs in the connection cap. The LED colors indicate:

- Green: Voltage is available
- Yellow: Trigger pulse

10.3.4 Running a Self Test



Operational safety!

If you conduct a self test, ensure that the following conditions are met in order to avoid equipment damage or personal injury:

- The MIC500 ignition controller may not be located in a potentially explosive area.
- The gas supply must be switched off.
- There may not be any residual gas in the combustion chamber.



Explosion hazard!

Reinsert the RS232 interface cover after each usage and tighten it with a tightening torque of 1 Nm (0.7 lb-ft).

To check the order of the wiring and the connection between the ignition controller outputs down to the spark plugs, you can run a self test.

To start the self test:

1. Turn on the supply voltage for the ignition controller.
2. Connect the computer or the hand-held programmer via the RS232 interface (serial interface/COM) to the ignition controller.
3. Launch the Ignition Control configuration software on the computer or switch the hand-held programmer on using the ON/OFF key.
4. Start the self test from the computer by pressing [Shift]+[S], or from the hand-held programmer by pressing [S].
 - ▶ All pre-selected outputs will be fired consecutively in 1/10-second intervals.



Note the assignment of the ignition outputs at the output connector

Note that the ignition outputs at the output connector of the individual device types are not always assigned to a pin or a pole with the same letter. The assignment of the ignition outputs to the pins or poles of the output connector can be found in chapter *Input and Output Wiring on the Controller* on page 28.



Misfire Detection

Which of the displayed outputs can actually be fired, depends on the set sequence number (see *Set Sequence Number* on page 80). The sequence of the ignition depends on the wiring of the ignition controller outputs with the ignition coils.

The following assessments can be run for the purpose of localizing errors:

- An oscilloscope at the measuring output of the ignition controller is used to measure the low-voltage-side output voltage and wave form.
- The output harness and the state of the ignition circuits can be evaluated by measuring the respective voltage at the output clamps.
- With the aid of a timing light, all high tension leads can be tapped. A consistent flash frequency indicates proper function.

5. To finish the self test, you have the following options:

- Computer: Press [Shift]+[S] or [Esc]
- Hand-held programmer: Press [S] or [ESC]

10.3.5 Customer Service Information

You can reach our customer service during business hours at the following phone and fax number, or by e-mail:

Phone: +49 5141 93 99 0

Fax: +49 5141 93 99 99

Email: service@motortech.de

10.3.6 Returning Equipment for Repair / Inspection

To return the device for repair and inspection, obtain a return form and return number from MOTORTECH.

Fill out the return form completely. The completely filled out return form guarantees fast, uncomplicated processing of your repair order.

10 ERRORS

Send the device and the return form to one of the two addresses below or to the nearest MOTORTECH representative:

MOTORTECH GmbH

Hogrevestr. 21-23
29223 Celle

Germany

Phone: +49 5141 93 99 0
Telefax: +49 5141 93 99 98

www.motortech.de
motortech@motortech.de

MOTORTECH Americas, LLC

1400 Dealers Avenue, Suite A
New Orleans, LA 70123

USA

Phone: +1 504 355 4212
Telefax: +1 504 355 4217

www.motortechamericas.com
info@motortechamericas.com

10.3.7 Instructions for Packaging the Equipment

For return shipment, equipment should be packaged as follows:

- Use packaging material that does not damage the equipment surfaces.
- Wrap the equipment with sturdy materials and stabilize it inside the packaging.
- Use sturdy adhesive film to seal the packaging.

11 MAINTENANCE

11.1 Maintenance Instructions

Please follow the following maintenance instructions:

- If you are using a passive (magnet) pickup, clean it at regular intervals.
- Check the ignition wires at regular intervals.
- Replace the pickup at regular intervals if operated under elevated temperature conditions ($>90^{\circ}\text{C}$ / $>194^{\circ}\text{F}$).
- Regularly inspect all wires of the ignition system for damage and replace the wires as needed.
- Check all plug-in connections for proper condition.
- Service the spark plugs as per the instructions of the spark plug and engine manufacturers.
- Use only a damp cloth to clean the ignition controller. Do not use a high-pressure device or similar.

11.2 Spare Parts and Accessories

For spare parts and accessories for MIC500 ignition systems, please refer to our current product guide, which is available for download at www.motortech.de.

12 INDEX

4	
4-20 mA input	
Activate	89
Current value	73
Function	62
Limits	95
Wiring	53
A	
Abbreviations	8
Alignment per cylinder	62, 87
B	
B Offset	
Setting	95
Buttons	
Ignition Control	68
C	
Cleaning	119
Configuration example	100
Cylinder-to-cylinder alignment	
Activate	87
Setting	103
D	
Declaration of Conformity	16
Device	
Application range	14
Cleaning	119
Dimensions.....	20, 23
Disposal	13
Electrical data	21
Function	14
Installation	27
Maintenance.....	119
Mechanical data.....	20
Product number	20
Product overview.....	15
Required current	21
Return	117, 118
Serial number	20
Start-up	110
Switching off.....	110
Temperature	20
Weight.....	20
Device type	
Product overview.....	15
Digital input	
Function	58, 59
Setting	87
Switch A/B.....	59
Switch Start/Stop	58
Wiring	56
Dimensions.....	20, 23
Disposal	13
E	
Electrostatics	11
Energy	
Current value	73, 102
Function.....	63
Setting.....	102
Error	
Acknowledge.....	112
Causes.....	111
Overspeed	111
Overviews.....	73, 111, 113
Pickup	112
Power supply	112
G	
Go/NoGo output	
Function.....	57
Wiring.....	56
H	
Hand-held programmer	
Configuration	69
Control panel	71
Keys	71
Operation	69
Switching on	70
Help	
Ignition Control	75
I	
Ignition Control	
Buttons.....	68
Installation	64
Menu bar	68
Operation	64
Start program.....	67
System requirements.....	64
Ignition energy	
Current value	73, 102
Function.....	63
Setting.....	102
Information	
On device.....	103

Input connector			
P/N 06.00.507	29	
P/N 06.00.508	29	
P/N 06.00.510	30	
P/N 06.00.511	32	
P/N 06.00.513	34	
P/N 06.00.514	36	
P/N 06.00.515	38	
P/N 06.00.516	40	
P/N 06.00.517	42	
P/N 06.00.520	44	
P/N 06.00.525	46	
P/N 06.00.530	48	
P/N 06.00.550	50	
Inputs			
Electrical data	21	
Installation	27	
Ignition Control	64	
Interfaces			
RS232	22, 23	
K			
Keys			
Hand-held programmer	71	
M			
Maintenance	119	
Menu bar			
Ignition Control	68	
MIC500			
Application range	14	
Cleaning	119	
Dimensions	20, 23	
Disposal	13	
Electrical data	21	
Function	14	
Installation	27	
Maintenance	119	
Mechanical data	20	
Operating hours	103	
Product number	20	
Product overview	15	
Required current	21	
Return	117, 118	
Serial number	20	
Start-up	110	
Switching off	110	
Temperature	20	
Weight	20	
Misfire detection			
Causes	111	
Current status	107	
Function	62	
Setting	86	
Misfire rate			
Setting	86	
MOTORTECH			
Address	117	
O			
Operating hours			
Access	103	
Operation			
Hand-held programmer	69	
Ignition Control	64	
Output connector			
P/N 06.00.507	29	
P/N 06.00.508	29	
P/N 06.00.510	30	
P/N 06.00.511	32	
P/N 06.00.513	34	
P/N 06.00.514	36	
P/N 06.00.515	38	
P/N 06.00.516	40	
P/N 06.00.517	42	
P/N 06.00.520	44	
P/N 06.00.525	46	
P/N 06.00.530	48	
P/N 06.00.550	50	
Outputs			
Electrical data	21	
Overspeed			
Exceeded	111	
Setting	84	
Overview			
Buttons	68	
Device types	15	
Menu bar	68	
Parameter	78	
Sequence number	80	

12 INDEX

P	
Parameter	
4-20 mA input	89, 95
Activate	75
B Offset	95
Configuration example	100
Cylinder-to-cylinder alignment	87, 103
Ignition timing offset	95
Limits	93
Misfire rate	86
Overspeed	84
Overview	78
Potentiometer	88, 91
Programming overview	107
Reset position	84
Security speed	85
Sequence number	80
Speed curve	89, 97
Switch A/B	87
Switch Start/Stop	87
Parameterization level	
Activate	75
Exit	75
Operation	75
Pickup	
Check	57, 114
Maintenance	119
Wiring	54
Potentiometer	
Activate	88
Setting	91
Power supply	
Wiring	52
Product number	20
Programming overview	107
R	
Regulations	
Overview	16
Required current	21
Reset position	
Setting	84
Return shipment	117, 118
RS232	22, 23
S	
Safety functions	
Overview	111
Safety instructions	10
Schedule	
Function	59
Limits	93
Setting	87, 89
Scope of supply	26
Security speed	
Setting	85
Self Test	105, 116
Sequence number	
Setting	80
Serial number	20
Shut off	110
Software	
Buttons	68
Installation	64
Menu bar	68
Operation	64
Start program	67
System requirements	64
Speed	
Current value	73
Speed Curve	
Activate	89
Function	62
Setting	97
Start-up	110
Status LED	23, 113
Switch A/B	
Activate	87
Wiring	56
Switch Start/Stop	
Activate	87
Function	58
Wiring	56
System requirements	
Ignition Control	64
T	
Temperature	20
Timing	
Alignment per cylinder	62, 87
Current value	73
Limits	93
Offset	95
Timing correction	
4-20 mA input	62
Manual	61
Offset	59
Overview	60
Per cylinder	62
Speed curve	62

W

Weight	20
Wiring	
4-20 mA input.....	53
Digital input	56
Go/NoGo output	56
Pickup.....	54
Power supply.....	52
Switch A/B	56
Switch Start/Stop.....	56

Original MOTORTECH Accessories for Stationary Gas Engines

As a supplier, MOTORTECH develops, produces and distributes accessories as well as spare and wearing parts for nearly all kinds of stationary gas engines worldwide: Ignition control and monitoring, industrial spark plugs and high tension leads, wiring systems and gas regulation – from detonation to speed control and complete gas engine management. On-site support and special training courses complete our service.



MOTORTECH GmbH

Hogrevestr. 21-23
29223 Celle
Germany
Phone: +49 5141 93 99 0
Fax: +49 5141 93 99 99
www.motortech.de
motortech@motortech.de

MOTORTECH Americas, LLC

1400 Dealers Avenue, Suite A
New Orleans, LA 70123
USA
Phone: +1 504 355 4212
Fax: +1 504 355 4217
www.motortechamericas.com
info@motortechamericas.com